

**DESCHUTES  
COUNTY  
FAMILY EMERGENCY  
PREPAREDNESS  
HANDBOOK**

Deschutes County Sheriff's Office  
Emergency Management



**Accommodation Information for People with Disabilities**  
To get this information in an alternate format please email  
[emergency.management@deschutes.org](mailto:emergency.management@deschutes.org) or, 541-617-3386; relay users dial 7-1-1).



# WHY PLAN FOR AN EMERGENCY?

Central Oregon is a beautiful place to live, but we are vulnerable to disasters, such as severe winter storms, wildfires, earthquakes, windstorms, volcanos, drought, floods and landslides. Many of these disasters have already occurred here and undoubtedly will again. During a disaster, you may be able to stay in your home, but it could be without power or water. This preparedness guide and family workbook will help you be ready for whatever emergencies may occur.

Deschutes County residents are fortunate that local emergency services have developed an effective and cooperative emergency response system. Throughout the county, agencies work together closely to prepare for any emergencies that come our way.

While agencies can be in a high state of readiness for disasters, there is no substitute for individual preparedness. **Deschutes County Emergency Management recommends that you plan to be on your own for a minimum of 72 hours, and preferably one month.** You are not being asked to deal with emergencies alone, but your individual preparedness efforts will allow emergency service agencies to work more effectively and efficiently to help everyone in the county. Depending on the scope and severity of the disaster, there may not be enough help to go around

The following pages outline a step-by-step guide to disaster planning. First and foremost you'll learn:

- Communication is the most important concept in developing an emergency preparedness plan for families
- Every family member needs to be involved
- Educating family members ahead of time will help reduce their fear if a disaster should occur

Your plan will work best when everyone in your family agrees to operate within its guidelines.

Once your family is prepared, it's time to look to your neighbors. In times of disaster, they will probably be the first ones available to come to your aid, or they may be in need of your help. Find out before disaster strikes what resources you share and how you can work together. Good luck! Please remember to review your plan every six months.

**You are responsible for your family's safety!**

**Start now; Start today!**



# TABLE OF CONTENTS

Page	Title
2.....	Family Disaster Planning
4.....	Home Hazard Hunt
6.....	Make a 1-Month Kit in 40 Weeks
19.....	Water in an Emergency
20.....	Family Contact Cards
23.....	Emergency Preparedness for Persons with Varied Abilities
25.....	Home Fire Safety
27.....	Fire Escape Plan
29.....	Smoke Alarms
30.....	Know Your Fire Extinguisher A, B, C's
31.....	Wildfire Preparedness
32.....	Evacuation
34.....	Sheltering in Place
35.....	Extreme Heat
36.....	Floods
37.....	Utility Failure
39.....	Winter Storms
40.....	Sanitation
41.....	Health Emergencies
43.....	Earthquakes
45.....	Hazardous Materials
47.....	Disaster Psychology
48.....	First Aid
51.....	Pet Preparedness
52.....	Livestock Preparedness
53.....	Motor Vehicle Preparedness
54.....	Deschutes Alerts Emergency Notification System
59.....	Other Area Resources

This emergency preparedness handbook was developed by Deschutes County Emergency Management and is based on a guide created by the Jackson County, Oregon Emergency Management Advisory Group. Deschutes County Emergency Management would also like to thank those who contributed to this handbook from Deschutes County Facilities Department, Deschutes County Risk Management, Deschutes County Health Services, Bend Fire Department, Redmond Fire and Rescue, Oregon Health Authority, Central Electric Coop, and Project Wildfire.



# FAMILY DISASTER PLANNING

**Where will your family be when a disaster strikes? What would you do if basic services like water, gas, electricity and telephones were cut off for long periods? What would you do if there was a shortage of supplies such as food, water or fuel?**

Whether faced with a family emergency or a regional disaster, the effort you've put into family preparedness and disaster planning will play a large role in how well you "survive" the event. The following steps can help you enhance your family's preparedness.

## IDENTIFY THE HAZARDS

Below are the hazards that may occur in Deschutes County. Visit the library, contact County Emergency Management or log on to the Federal Emergency Management Agency (FEMA) website at [www.fema.gov](http://www.fema.gov) to learn more about each hazard.

Winter storm	Drought
Wildfire	Flood
Major earthquake (Cascadia)	Earthquake (crustal)
Windstorm	Landslide
Volcano	Hazardous material spill

## LEARN HOW THE HAZARDS CAN IMPACT YOUR FAMILY

Think about how each hazard might affect your family:

- What if your family members were at work or school?
- Would you be impacted differently if the weather was very warm or very cold?
- How would you get by if utilities were interrupted?
- How would you handle damage to your property or blocked roads?
- Find out about the disaster plan at your workplace, your children's school or childcare center and other places your family frequents

## IDENTIFY STEPS YOU CAN TAKE TO MINIMIZE OR PREVENT HAZARD IMPACTS

- Create plans for home escape, neighborhood evacuation and family communication
- Learn procedures for Drop! Cover! Hold On!, shelter-in-place and utilities shut-off
- Obtain training in CPR, basic first aid and the use of a fire extinguisher
- Use hazard-resistant construction materials and fire-resistant plants
- Implement flood mitigation, landscaping and site drainage practices
- Learn non-structural earthquake hazard mitigation techniques
- Install warning systems (e.g., smoke alarms, AM/FM/NOAA radio, etc.)

**IDENTIFY EQUIPMENT AND SUPPLIES YOU’LL NEED TO  
HELP SURVIVE POTENTIAL CONSEQUENCES**

- Food and water
- First aid supplies
- Sanitation supplies
- Clothing and bedding
- Prescription and non-prescription medications
- Light sources (flashlight, lantern, headlamp)
- Tools, equipment and supplies (manual can opener, utensils, fire extinguisher, matches, money, batteries, etc.)
- Special items (baby supplies, pet food, important family documents, etc.)

**USE THE 1-MONTH KIT CHECKLIST FOUND ON PAGE 6**

**IDENTIFY THE EQUIPMENT, SUPPLIES PROCEDURES AND  
PRACTICES YOU ALREADY HAVE IN PLACE**

- Camping gear (sleeping bags, cooking equipment, utensils, etc.)
- Fire escape plan (page 27)
- Extra food and water
- First aid kit

**IDENTIFY YOUR SHORTFALLS**

What equipment, supplies, procedures and plans do you need to complete your family preparedness effort?

**DEVELOP A PLAN TO ELIMINATE THE SHORTFALLS**

For the short term, focus on items that are low cost, or are easy to implement and that have a high payoff. Some suggestions include:

- Install hazard warning systems such as smoke alarms and purchase an AM/FM/NOAA radio
- Develop fire escape and neighborhood evacuation plans
- Develop a simple family communications plan such as wallet card with common number to call and important policy numbers (see page 20)
- Develop Drop! Cover! Hold On!, utility shut-off and shelter in place procedures
- Attend CPR, basic first aid, and fire extinguisher training
- Begin or expand your disaster supplies kit. Start with the basic necessities such as food, water, light sources, first aid supplies, clothing and bedding (see page 6)
- Host a neighborhood meeting to exchange preparedness information and ideas (many neighborhoods have neighborhood associations)

For the long-term, focus on higher cost items or those that are more difficult to implement.

- Special tools and equipment
- Drainage improvements
- Structural earthquake mitigation
- Building retrofitting

**TRAIN AND MAINTAIN**

- Conduct emergency evacuation drills
- Practice utility shut-off, Drop! Cover! Hold On! and shelter-in-place procedures
- Test smoke alarms monthly
- Replace stored food, water, and medicines before the expiration date
- Test communication plans

**DID YOU  
KNOW?**

Scientists predict a 37% chance the Pacific Northwest region will fall victim to another Cascadia Earthquake before 2060. This earthquake could measure between a 8.7 and a 9.2 in magnitude. The last “Cascadia” was in 1700.



# HOME HAZARD HUNT

***Do you believe that your home is a safe place to be? Statistics show that most fires, accidents and injuries occur in the home.***



An important step in family preparedness is the identification of hazards in your home. Once the hazards are identified, it doesn't take much time or effort to make your home a safer place to live.

**Getting Started:** Using the checklist below, involve the whole family, especially your children, in a home hazard hunt. Remember, anything that can move, break, fall or burn is a potential hazard. Foresight, imagination and common sense are the only tools you will need! After identifying what needs to be done, devise a plan to do it.

## **Kitchen**

- Wear snug-fitting clothes while cooking
- Do not leave cooking food unattended
- Keep pan handles turned in while cooking
- Keep a pan lid nearby in case of fire
- Keep cooking areas clean and clear of combustibles
- Keep cords from dangling
- Ensure outlets near the kitchen sink are GFI (Ground Fault Interrupt) equipped
- Keep sharp knives out of the reach of children

## **Outside**

- Clear dry vegetation and rubbish from around the house; clip limbs that overhang the roof
- Use grills away from buildings and vegetation
- Dispose of barbecue briquettes in a metal container
- Stack firewood away from your house and deck
- Chip and compost your yard debris, or take it to a recycling center instead of burning
- If you must burn, check with the fire department before burning debris or using a burn barrel
- Clear combustible materials from around your home in a 30 foot radius
- Assess areas around your home for hazard trees. Call an arborist for professional advise and removal services
- Secure any items that may become airborne in a wind event

## **All Rooms**

- Ensure floor coverings (rugs, carpets) are properly secured to prevent tripping hazards
- Separate draw cords on blinds and drapes to reduce strangulation hazards for kids
- Ensure room exits are unobstructed

## **Smoking and Matches**

- Store matches and lighters out of reach of children
- Use large, deep, non-tip ashtrays
- Never smoke when drowsy or in bed
- Dispose of ashes and cigarette butts in a metal can at least daily
- Check furniture for smoldering cigarettes every night, especially after parties

## **Electricity**

- Avoid the use of extension cords (if used, ensure the correct wattage rating)
- Plug only one heat producing device into an electrical outlet
- Ensure cords are not placed under rugs
- Verify circuits are not overloaded
- Replace damaged cords, plugs, sockets
- Use bulbs with the correct wattage for lamps and fixtures
- Check fuses/circuit breakers for the correct amperage ratings
- Do not override or bypass fuses or circuit breakers

## **Clothes Washer/Dryer**

- Verify that appliances are properly grounded
- Ensure lint filter is clean and serviceable
- Check vent hose and vent line to ensure they are clean and provide unobstructed airflow



# HOME HAZARD HUNT

## Garage/Attic/Shed

- Use gasoline as a motor fuel only and never use or store it inside the home
- Keep only a small quantity of gasoline, if necessary, in an approved container locked in the garage or shed
- Keep flammable liquids such as paints and thinners in their original containers and store on or near the ground and away from sources of heat, sparks or flame
- Store used oily rags in sealed metal containers and dispose of properly

## Heating Equipment

- Ensure fireplace inserts and gas/wood stoves comply with local codes
- Clean and inspect chimney annually
- Dispose of ashes in metal container
- Keep clothes, furnishings, and electrical cords at least 12" away from wall heaters and 36" from portable heaters
- Service furnace annually
- Set water heater thermostat at 120 degrees F
- Elevate new or replacement gas water heaters at least 18" above the floor

## Bathrooms

- Store poisonous cleaning supplies and medicines in "child-proofed" cabinets
- Replace glass bottles with plastic containers
- Ensure all outlets are GFI equipped

## Family Preparedness

- Plan two unobstructed exits from every room, including the second floor, and make sure everyone knows them
- Designate a meeting place outside
- Have an out-of-state contact for family check-in after a disaster/emergency
- Develop an escape plan and practice it regularly
- Store important papers and valuables in a fire-proof safe or cabinet
- Maintain proper insurance coverage for your home and its contents (earthquake, flood, renters, fire)

## Fire Extinguisher

- Verify that an all-purpose fire extinguisher (Class ABC) is maintained in an accessible location
- Ensure that all occupants know how to use it
- Additional fire extinguishers kept in the kitchen, garage, basement and sleeping area

## Smoke Alarms

- Installed properly on every level
- Tested 1st Tuesday of each month
- Batteries replaced every six months at the time change

## Earthquake Hazards (all rooms)

- Bolt heavy, tall, upright furniture to wall studs
- Lock or remove rollers on beds, furniture, and appliances
- Secure hanging plants and light fixtures with one or more guy wires to prevent swinging into walls or windows and breaking
- Locate beds away from windows and heavy wall-mounted objects
- Secure kitchen and bathroom cabinets with "positive" (self-closing) latches
- Secure items on shelves with quake putty, mats, Velcro, low shelf barriers, etc.
- Store heavy and/or breakable items on lower shelves
- Strap water heater to wall studs
- Use flexible connections on gas appliances
- Check chimney for loose bricks and repair as needed
- Check foundation for cracks and repair as needed
- Bolt home to foundation to prevent shifting during an earthquake
- Secure mirrors and pictures to the wall or hang them with heavy wire, looped through eye screws or tongue-in-groove hangers.





# MAKE A 1-MONTH KIT IN 40 WEEKS

The following guide was developed by Deschutes County Sheriff's Office Emergency Management to help county residents identify, prepare and store goods for 30 days in case of an emergency or disaster. This guide also helps users identify a "break-out" portion of the most essential goods that can be used as a go-kit in case of an emergency evacuation.

The state of Oregon Office of Emergency Management recommends that all Oregon residents have at least two weeks' worth of goods and supplies stored and accessible for each member of their family. However, the hazards we face in Deschutes County are unique to those in other parts of the state. Deschutes County receives most of its goods from other areas, and an event that affects road transportation routes, such as a large-scale "Cascadia" earthquake, or a winter storm, could impact the ability for county residents to buy food and other goods that they don't already have on hand.

Additionally, in the event of a disaster, it could be days or weeks before the county received any help from outside areas. The ultimate responsibility for basic preparedness lies with each individual and/or family unit.

We also recognize that it can be not only overwhelming, but time consuming and expensive to commit to building a supply kit all at once. Therefore, this plan was developed to help guide citizens in creating a 30-day supply of goods for each person in their household over the course of 40 weeks: this helps spread out the costs associated with buying new supplies, and will also make this project more manageable for those who are just getting started. The first few weeks are designed to be a little "heavier" with items to purchase, and the tasks and items to buy evens out throughout the remaining weeks.

Here are some general guidelines to keep in mind as you begin this project:

- This checklist is meant to guide one average adult through gathering and purchasing basic necessities to sustain them for 72 hours away from home without additional assistance OR one month at home. Addendums to this list have been created for families with babies, small children, access and functional needs, and other considerations. These lists should not be treated as 100% exhaustive. Please think outside the box and consider all of your family's needs before undertaking this planning effort.
- There may be situations, depending on your circumstances and the nature of the disaster, when it's simply best to stay where you are and avoid any uncertainty outside by "sheltering in place."
- Conversely, the situation or disaster may dictate that you need to leave your home and evacuate. This plan addresses both scenarios by building a one-month kit when a small portion of supplies set aside for your 72 hour "go bag."
- Before you head to the store, look over this checklist and gather items you already have and put them in your tote or backpack. Check items off as you go.
- An important note about your BACKPACK versus your TOTE: Items in your backpack should be the most vital. This backpack is what you will take with you if you have to leave your home on foot.





# MAKE A 1-MONTH KIT IN 40 WEEKS

- Backpack items are underlined on the checklist
- This backpack can be stored in the same place as your emergency supply tote, so there's no need to double up the supplies unless you want to. This pack is only for use if you absolutely have to leave your home and you don't have time to grab other supplies.
- Backpack items are placed in the first few weeks of the checklist because they're the most important.
- **WATER**
  - 1 gallon per person per day is the general standard
  - That does not allow for a ton of cooking water or personal hygiene water
  - Extra water can be located in your water heater, toilet tanks (not the bowl)
  - Make sure you have the necessary tools on hand to drain your water heater and/or siphon water from your toilet tank(s) as well as supplies to treat potentially contaminated water

<p><u>Baby/small children:</u></p> <ul style="list-style-type: none"> <li>• Diapers</li> <li>• Formula</li> <li>• Baby food</li> <li>• Extra bottles/nipples <ul style="list-style-type: none"> <li>• Diaper wipes</li> <li>• Extra clothing</li> </ul> </li> <li>• Burp rags/small blankets</li> <li>• Teething tablets/gel</li> <li>• Pedialyte or similar <ul style="list-style-type: none"> <li>• Pacifiers</li> </ul> </li> <li>• Infant Tylenol and Motrin <ul style="list-style-type: none"> <li>• Baby Powder</li> <li>• Diaper rash cream</li> </ul> </li> <li>• Ziploc baggies for diapers <ul style="list-style-type: none"> <li>• Sippy cup</li> <li>• Comfort item(s)</li> </ul> </li> </ul>	<p><u>Pets &amp; service animals:</u></p> <ul style="list-style-type: none"> <li>• Food</li> <li>• Spare ID tags</li> <li>• Leashes</li> <li>• Carriers</li> <li>• Kitty litter/litter box</li> <li>• Extra water for pets</li> </ul>	<p><u>Other needs:</u></p> <ul style="list-style-type: none"> <li>• Denture care</li> <li>• Feminine hygiene items</li> <li>• Contacts/supplies</li> <li>• Eyeglasses</li> <li>• Hearing aid batteries</li> <li>• Rx meds, injectables, oxygen, etc. (it is generally not recommended to stockpile medications. Talk with your doctor and/or pharmacist)</li> <li>• Diabetic supplies, test strips, etc.</li> <li>• Medic alert tags/bracelet</li> <li>• Communication aids</li> <li>• Wheelchair/accessories</li> <li>• Spare cane/walker</li> </ul>
---	---	---



# Week 1

- Backpack\*
- Extra large plastic tote\*
- Flashlight and extra batteries\*
- Whistle\*
- Dust mask\*
- Toothbrush/toothpaste\*
- 3 days' worth of high-calorie food\*
- 3 days worth of bottled water\*
- Cash (small bills)
- Spare keys
- 1 roll toilet paper\*

## THINGS TO DO:

- Identify an area in your home to safely store your supplies (dry and room temperature)
- Sign up for Deschutes Alerts to receive a call or text in case of an emergency ([deschutes.org/911/alerts](https://deschutes.org/911/alerts))
- Connect to the Central Oregon Emergency Information Network to stay up-to-date in an emergency
- Twitter: @COEmergencyInfo
- Facebook: @COEmergencyInfo
- Blog: [coemergencyinfo.blogspot.com](http://coemergencyinfo.blogspot.com)

# Week 2

- Deluxe first aid kit
- Pain reliever
- Laxatives
- 2 bottles antacid
- Scissors
- Tweezers
- Thermometer
- Petroleum jelly
- Rubbing alcohol
- Anti-diarrheal
- Antiseptic ointment
- Multi-vitamins
- Prescription meds
- Important documents in a waterproof container/bag
- Warm/waterproof clothing
- Comfort items

## THINGS TO DO:

- Gather copies of important documents OR scan documents onto a secure internet-based cloud server (passports, driver's license, marriage/birth certificates, vehicle titles, social security cards, immunization records, pet records)

## Week 3

- 1 “case” of water or equivalent\*
- Paper and pen
- Local paper map
- Heavy cotton or hemp rope
- Duct tape
- 2 flashlights or headlamps w/ batteries
- 1 10lb bag of rice

### THINGS TO DO:

- Find out about what kinds of disasters can happen in Deschutes County (<https://goo.gl/xxJHWL>)
- Date perishable items with marker (continual)
- Decide on and notify an out-of-area contact who can coordinate information for family members. Coach family members how to call/text this person and what to say

**\*PER PERSON**

## Week 4

- Flashing safety light or light wand
- Compass
- Waterproof matches
- Portable stove or grill
- Stove fuel
- 1 hand-operated can opener
- Permanent marker

### THINGS TO DO:

- Develop a family disaster plan including where to meet if separated, name and number of out-of-area contact, kinds of information to give that contact in an emergency (see Week 3)
- Develop kid-friendly contact cards for any children in your family

Week 5	Week 6
<ul style="list-style-type: none"> <li>☐ 2 “cases” of water or equivalent*</li> <li>☐ 4 cans fruit cocktail*</li> <li>☐ 4 cans chili*</li> </ul> <p><b>THINGS TO DO:</b></p> <ul style="list-style-type: none"> <li>☐ Identify escape routes from the house for all family members</li> <li>☐ Identify safe places to go in case of fire, flood, earthquake or other disaster</li> </ul> <p><b>*PER PERSON</b></p>	<ul style="list-style-type: none"> <li>☐ 4 boxes pasta*</li> <li>☐ 8 cans ready-to-eat soup*</li> </ul> <p><b>THINGS TO DO:</b></p> <ul style="list-style-type: none"> <li>☐ Practice a drill for each of your evacuation plans (Week 4)</li> <li>☐ Download and start reading the Deschutes County Family Emergency Preparedness Handbook (<a href="http://sheriff.deschutes.org/preparedness_handbook.pdf">sheriff.deschutes.org/preparedness_handbook.pdf</a>)</li> </ul> <p><b>*PER PERSON</b></p>
Week 7	Week 8
<ul style="list-style-type: none"> <li>☐ Extra pair of shoes*</li> <li>☐ Flashlight w/batteries*</li> <li>☐ Extra whistle*</li> <li>☐ Work gloves*</li> </ul> <p><b>THINGS TO DO:</b></p> <ul style="list-style-type: none"> <li>☐ Place above items inside a small bag and tie it to the foot of your bed in case of an earthquake</li> </ul> <p><b>*PER PERSON</b></p>	<ul style="list-style-type: none"> <li>☐ Warm clothes, socks*</li> <li>☐ Blankets*</li> <li>☐ Cooking pot</li> <li>☐ Utensils*</li> <li>☐ Plate, cup, bowl*</li> </ul> <p><b>*PER PERSON</b></p>

## Week 9

- 3 rolls toilet paper\*
- Extra stove fuel\*

### THINGS TO DO:

- Replace smoke alarm batteries and download an app or create an electronic calendar reminder to do this every 6 months. Consider using the “Alarmed” free smart phone app. Change the batteries when you change your clocks for daylight savings.

**\*PER PERSON**

## Week 10

- Gas shutoff wrench
- Pry bar

### THINGS TO DO:

- Make sure everyone knows where to find the gas and water shut off valves and how to turn them off
- Consider attaching your gas shutoff wrench to your gas meter so it’s there when needed

## Week 11

- Portable battery charger for electronics (10,000 mAh or greater)
- Spare electronics charging cables

### THINGS TO DO:

- Using your reminder app, set a reminder to recharge your portable battery every few weeks

**\*PER PERSON**

## Week 12

- 1 “case” of water or equivalent\*
- 4 cans tuna\*
- 4 cans chicken\*

### THINGS TO DO:

- Research First Aid certification classes and sign up for one if you aren’t already certified

**\*PER PERSON**

Week 13	Week 14
<ul style="list-style-type: none"> <li>☐ Battery-powered AM/FM/NOAA radio with extra batteries, or with hand crank</li> <li>☐ 3 rolls toilet paper*</li> </ul> <p><b>THINGS TO DO:</b></p> <ul style="list-style-type: none"> <li>☐ Ensure all perishables have been dated, and use your reminder app to create rotation reminders</li> </ul> <p><b>*PER PERSON</b></p>	<ul style="list-style-type: none"> <li>☐ 1 package of cookies*</li> <li>☐ 4 boxes of granola bars*</li> </ul> <p><b>THINGS TO DO:</b></p> <ul style="list-style-type: none"> <li>☐ Check with your children’s day care or school about their disaster plans and how parents will be contacted if a disaster happens during business hours</li> </ul> <p><b>*PER PERSON</b></p>
Week 15	Week 16
<ul style="list-style-type: none"> <li>☐ Pliers or multi-tool</li> <li>☐ Screwdriver (Phillips and standard)</li> <li>☐ Hammer</li> </ul> <p><b>THINGS TO DO:</b></p> <ul style="list-style-type: none"> <li>☐ Check with any local family or friends who may have access or functional needs to see how you can incorporate them into your planning effort</li> </ul>	<ul style="list-style-type: none"> <li>☐ 2 jars peanut butter*</li> <li>☐ 1 box saltines*</li> <li>☐ 1 box graham crackers*</li> </ul> <p><b>THINGS TO DO:</b></p> <ul style="list-style-type: none"> <li>☐ Mimic the supplies in your backpack (Week 1/2) for a vehicle emergency kit, or buy a pre-made kit</li> </ul> <p><b>*PER PERSON</b></p>

Week 17	Week 18
<ul style="list-style-type: none"> <li>❑ 5 gallon bucket for toileting</li> <li>❑ 5 gallon trash bag liners</li> <li>❑ 3 rolls of toilet paper*</li> <li>❑ Container of quicklime (to sprinkle on waste between uses)</li> </ul> <p><b>THINGS TO DO:</b></p> <ul style="list-style-type: none"> <li>❑ The average person produces 2-3 pints of urine and about a pound of feces per day. If sewer and water services are not available, having a plan to deal with human waste can make all the difference</li> </ul> <p><b>*PER PERSON</b></p>	<ul style="list-style-type: none"> <li>❑ 3 boxes of instant oatmeal*</li> <li>❑ 4 cans fruit*</li> <li>❑ Extra stove fuel</li> </ul> <p><b>THINGS TO DO:</b></p> <ul style="list-style-type: none"> <li>❑ Make standing arrangements with someone to help your children, pets, or family with special needs if you are at work or otherwise unable to return home during a disaster</li> </ul> <p><b>*PER PERSON</b></p>
Week 19	Week 20
<ul style="list-style-type: none"> <li>❑ Household liquid bleach</li> <li>❑ Eye dropper</li> <li>❑ Water filtration system</li> </ul> <p><b>THINGS TO DO:</b></p> <ul style="list-style-type: none"> <li>❑ Research water storage methods, rotation timelines, and ways to purify and/or filter water</li> </ul>	<ul style="list-style-type: none"> <li>❑ Electrolyte tabs or powder</li> <li>❑ 12 Ramen or instant noodles*</li> </ul> <p><b>THINGS TO DO:</b></p> <ul style="list-style-type: none"> <li>❑ Assemble an age-appropriate activity box with playing cards, games, and other favorite toys and books</li> </ul> <p><b>*PER PERSON</b></p>

## Week 21

- Sunscreen
- Safety pins
- Liquid antibacterial soap

### THINGS TO DO:

- Review your insurance coverage with your agent to be sure you are covered for whatever disasters might occur in your area

## Week 22

- Favorite comfort foods\*
- 4 cans stew\*
- 4 cans vegetables\*

### THINGS TO DO:

- Purchase and install emergency escape ladders for upper floor windows

**\*PER PERSON**

## Week 23

- 12 rolls paper towels
- Gallon Ziploc bags

### THINGS TO DO:

- Photograph or videotape the contents of your home and send the file(s) to an out-of-town friend or relative to store, or store them on your secure cloud server online

## Week 24

- 4 cans stew\*
- 4 cans beans\*

### THINGS TO DO:

- Begin rotating food and water stores, replacing those purchased during Week 1. Check that your storage area is safe and dry. Continue rotation each month so that fresh stores are always on hand. Use your reminder app.



## Week 25

- Toilet seat lid made for a 5 gallon bucket OR a pool noodle split length-wise
- Disinfectant spray

### THINGS TO DO:

- Update your out-of-area contact if needed. Consider doing a simple drill involving 1-2 family members and your out-of-area contact. Practice using the out-of-area contact as a go-between for simple messages.

## Week 26

- 1 large jar jelly\*
- 1 large jar honey\*
- Extra stove fuel

### THINGS TO DO:

- Encourage friends and family who live in or visit Deschutes County to sign up for Deschutes Alerts (Week 1)

**\*PER PERSON**

## Week 27

- Roll of plastic sheeting
- Extra roll of duct tape

### THINGS TO DO:

- Identify areas in your home that would need to be taped off with duct tape and plastic sheeting in case of a chemical spill or other toxic vapor emergency. Windows, doors, vents and any access to the outside should be sheeted off.

## Week 28

- 4 cans pears\*
- 4 cans pineapple\*
- 4 cans corn\*

**\*PER PERSON**

## Week 29

- Assorted plastic containers with lids

### THINGS TO DO:

- Check with your insurance company to see if they provide internet-based software to log and inventory your high-value items. If not, create your own spreadsheet and print it out or store it securely on the cloud. Make sure your pictures and/or video from Week 23 show these items.

## Week 30

- 4 cans green beans\*
- 4 cans mandarin oranges\*

### THINGS TO DO:

- Practice a drill for each of your evacuation plans
- Practice meeting at each location listed on your wallet card (Week 8)

**\*PER PERSON**

## Week 31

- 1 bar of soap\*
- 1 bottle of conditioner
- 1 bottle of shampoo

**\*PER PERSON**

## Week 32

- 2 lbs powdered milk\*
- 3 rolls of toilet paper\*
- 6 boxes easy stovetop-style meals\*

**\*PER PERSON**

<h2 style="text-align: center;">Week 33</h2>	<h2 style="text-align: center;">Week 34</h2>
<ul style="list-style-type: none"> <li>☐ 2 boxes heavy-duty garbage bags</li> <li>☐ Snow shovel</li> </ul>	<ul style="list-style-type: none"> <li>☐ 2 packages spaghetti noodles*</li> <li>☐ 2 jars spaghetti sauce*</li> </ul> <p><b>THINGS TO DO:</b></p> <ul style="list-style-type: none"> <li>☐ Practice shutting off the gas and water to your home. <b>DO NOT ACTUALLY SHUT OFF THE GAS</b>, as it takes a professional to turn it back on.</li> </ul> <p><b>*PER PERSON</b></p>
<h2 style="text-align: center;">Week 35</h2>	<h2 style="text-align: center;">Week 36</h2>
<ul style="list-style-type: none"> <li>☐ Shaving razors*</li> <li>☐ Shaving cream</li> <li>☐ Deodorant*</li> </ul> <p><b>THINGS TO DO:</b></p> <ul style="list-style-type: none"> <li>☐ Check the charge on your portable electronics' spare battery. Update your reminder app as necessary.</li> </ul> <p><b>*PER PERSON</b></p>	<ul style="list-style-type: none"> <li>☐ 6 boxes easy stovetop-style meals*</li> <li>☐ Extra stove fuel</li> </ul> <p><b>*PER PERSON</b></p>

# Week 37

- ❑ 1 “case” of bottled water or equivalent\*
- ❑ 1 box of favorite crackers\*

**\*PER PERSON**

# Week 38

- ❑ Aluminum foil
- ❑ Plastic-wrap for food

# Week 39

- ❑ 4 boxes of facial tissue\*
- ❑ Safety goggles

**\*PER PERSON**

# Week 40

- ❑ Lotion
- ❑ Sewing kit w/extra needles
- ❑ Disposable hand wipes





# WATER IN AN EMERGENCY

*If an earthquake, winter storm, or other disaster strikes your community, you might not have access to food and water for days or even weeks. Take some time now to store emergency food and water supplies.*

## WATER—THE ABSOLUTE NECESSITY

You and your family can survive for many days without food, but only a short time without water. Following an earthquake or other emergency, there may be significant damage to regional and local water supply systems and even wells. Having an ample supply of clean water is a top priority in an emergency. Store a minimum of a 3-day supply of water for each family member. One gallon per person per day is recommended for drinking, cooking and washing. Remember to include water for your pets. Write the date on the water containers and replace the water every six months.



### Outdoor Water Sources

If you need to seek water outside your home, you can use these sources. Be sure to purify the water before drinking it:

- Rainwater
- Ponds and lakes
- Natural springs
- Streams, rivers, and other moving bodies of water

### **Purify water:**

You will need to ensure that your water is safe to drink. Visit [www.cdc.gov/healthywater](http://www.cdc.gov/healthywater) or [www.ready.gov/water](http://www.ready.gov/water) for more specific information.

### **How to Store Water:**

Store your water in thoroughly washed, plastic, glass, fiberglass, or enamel-lined metal containers. Never use a container that has held toxic substances. Plastic containers such as soft-drink bottles, are best. You can also purchase food grade plastic buckets or drums. Rotate water every six months. Store in a place sheltered enough to prevent freezing.

### Indoor Water Sources

**Ice cubes**—Melt and use

**Toilet Tank** (not the bowl): Contains clean water which can be used directly from the tank. Do not use this water if you have added any chemical treatments (cleaners) to the tank.

**Hot Water Heater:** Be sure electricity or gas are turned off. Open the drain at the bottom of the tank. Start the water flowing by turning off the water intake valve and turning on a hot water faucet. Do not turn on the gas or electricity when the tank is empty.

**Never drink or cook with water from a water bed!** It contains an algacide that can make you very sick.

### **REMEMBER:**

Never ration water. Drink the amount you need today, and try to find more for tomorrow!



## FAMILY CONTACT CARDS

Family contact cards are an important tool to help your family members stay in touch with each other during an emergency. Planning ahead can reduce the time it takes to contact each of your family members during an emergency. It is important that you know where everyone is and whether or not they are safe.

Sometimes during an emergency, local phone circuits are busy, but calls can still be made to other area codes. It may be easier for you to reach someone out of the area (maybe even in another state) than to reach someone in the same city. Designate a friend or family member who lives out of the area to collect and pass information between your immediate family members. Also consider using text messaging (no photos), which uses up less cellular network than calling.

Pick a safe place for your family to meet if there is no other way to contact each other. If all phone lines are out, plan for each family member to go to the designated meeting place to wait for others.

Two family contact cards are located on the following pages. Make necessary copies for each member of your family, then fill them out. Each member of your family should carry these cards with them at all times. Make sure caregivers for younger children have this information on file. If a disaster occurs during work or school hours, it's critical that everyone, including children or their caregivers, know who to contact and where to meet. Be sure to keep the cards updated as information changes.





Write your family's name above  
**Family Emergency Communication Plan**

**HOUSEHOLD INFORMATION**

Home #: .....  
Address: .....  
Name: ..... Mobile #: .....  
Other # or social media: ..... Email: .....  
Important medical or other information: .....  
Name: ..... Mobile #: .....  
Other # or social media: ..... Email: .....  
Important medical or other information: .....

Name: ..... Mobile #: .....  
Other # or social media: ..... Email: .....  
Important medical or other information: .....

Name: ..... Mobile #: .....  
Other # or social media: ..... Email: .....  
Important medical or other information: .....

**SCHOOL, CHILDCARE, CAREGIVER, AND WORKPLACE EMERGENCY PLANS**

Name: .....  
Address: .....  
Emergency/Hotline #: ..... Website: .....  
Emergency Plan/Pick-Up: .....

Name: .....  
Address: .....  
Emergency/Hotline #: ..... Website: .....  
Emergency Plan/Pick-Up: .....

Name: .....  
Address: .....  
Emergency/Hotline #: ..... Website: .....  
Emergency Plan/Pick-Up: .....

Name: .....  
Address: .....  
Emergency/Hotline #: ..... Website: .....  
Emergency Plan/Pick-Up: .....

**IN CASE OF EMERGENCY (ICE) CONTACT**

Name: ..... Mobile #: .....  
Home #: ..... Email: .....  
Address: .....

**OUT-OF-TOWN CONTACT**

Name: ..... Mobile #: .....  
Home #: ..... Email: .....  
Address: .....

**EMERGENCY MEETING PLACES**

Indoor: .....  
Instructions: .....  
Neighborhood: .....  
Instructions: .....

Out-of-Neighborhood: .....  
Address: .....  
Instructions: .....

Out-of-Town: .....  
Address: .....  
Instructions: .....

**IMPORTANT NUMBERS OR INFORMATION**

Police: ..... Dial 911 or #: .....  
Fire: ..... Dial 911 or #: .....  
Poison Control: ..... #: .....  
Doctor: ..... #: .....  
Doctor: ..... #: .....  
Pediatrician: ..... #: .....  
Dentist: ..... #: .....  
Medical Insurance: ..... #: .....  
Policy #: .....  
Medical Insurance: ..... #: .....  
Policy #: .....  
Hospital/Clinic: ..... #: .....

Pharmacy: ..... #: .....  
Homeowner/Rental Insurance: ..... #: .....  
Policy #: .....  
Flood Insurance: ..... #: .....  
Policy #: .....  
Veterinarian: ..... #: .....  
Kennel: ..... #: .....  
Electric Company: ..... #: .....  
Gas Company: ..... #: .....  
Water Company: ..... #: .....  
Alternate/Accessible Transportation: ..... #: .....  
Other: .....  
Other: .....







Ready



Write your family's name above

Family Emergency Communication Plan

HOUSEHOLD INFORMATION

Home #:
Address:
Name: Mobile #:
Other # or social media: Email:
Important medical or other information:

Name: Mobile #:
Other # or social media: Email:
Important medical or other information:

Name: Mobile #:
Other # or social media: Email:
Important medical or other information:

SCHOOL, CHILDCARE, CAREGIVER, AND WORKPLACE EMERGENCY PLANS

Name:
Address:
Emergency/Hotline #: Website:
Emergency Plan/Pick-Up:

Name:
Address:
Emergency/Hotline #: Website:
Emergency Plan/Pick-Up:

Name:
Address:
Emergency/Hotline #: Website:
Emergency Plan/Pick-Up:

Name:
Address:
Emergency/Hotline #: Website:
Emergency Plan/Pick-Up:

IN CASE OF EMERGENCY (ICE) CONTACT

Name: Mobile #:
Home #: Email:
Address:

OUT-OF-TOWN CONTACT

Name: Mobile #:
Home #: Email:
Address:

EMERGENCY MEETING PLACES

Indoor:
Instructions:

Neighborhood:
Instructions:

Out-of-Neighborhood:
Address:
Instructions:

Out-of-Town:
Address:
Instructions:

IMPORTANT NUMBERS OR INFORMATION

Police: Dial 911 or #:
Fire: Dial 911 or #:
Poison Control: #:
Doctor: #:
Pediatrician: #:
Dentist: #:
Medical Insurance: #:
Policy #:
Hospital/Clinic: #:

Pharmacy: #:
Homeowner/Rental Insurance: #:
Policy #:
Flood Insurance: #:
Veterinarian: #:
Kennel: #:
Electric Company: #:
Gas Company: #:
Water Company: #:
Alternate/Accessible Transportation: #:
Other:

FOLD HERE

FOLD HERE

FOLD HERE

FOLD HERE





# EMERGENCY PREPAREDNESS FOR PERSONS WITH VARIED ABILITIES

Anyone with a disability, or who lives with, works with, or assists a person with a disability or special need, should create a disaster plan. For some individuals, being notified of, and responding to, a disaster may be more difficult because of a disability. Disabilities may be physical, mental, emotional, ethnic, socio-economic, cultural, or language-based. Addressing special needs ahead of time will reduce the physical and emotional trauma caused by the emergency.

## All Persons With Special Needs

- Go to <https://goo.gl/F15i8R> to sign up for emergency alerts for Deschutes County. It is vital for every citizen in the county to sign up for this free service so that emergency services can alert you if there's a disaster or an emergency in your area. If you need assistance signing up, call 541-617-3386.
- If you currently use a personal care attendant from an agency, check with the agency to see if they have special provisions for emergencies.
- If you hire your own personal care attendant, discuss your emergency plan with him/her and encourage them to have their own emergency plan.
- Determine what you will do in each type of emergency.
- Learn what to do in case of power outages. Know how to connect or start a back-up power supply for essential medical equipment. Write it down in clear directions, and attach it to the power supply.
- Arrange for a relative or neighbor to check on you in an emergency.
- Keep your medications and aids in a consistent place. Keep extra aids in a second place, if possible.
- Keep extra supplies of the special items you need, including extra batteries for those items. Be sure to rotate out any items that expire.
- If you are on oxygen, dialysis, or have mobility needs, make plans with your caregivers, medical providers, and friends/family.
- Service animals may become confused or frightened. Keep them confined or securely leashed.

## Persons with Mobility Challenges

- Store emergency supplies in a pack or backpack attached to your walker, wheelchair, or scooter.
- Keep a pair of heavy gloves in your supply kit to use while wheeling over glass or debris.
- If your chair does not have puncture-proof tires, keep a patch kit or a can of sealant and air to repair tires.
- If you cannot use stairs, discuss lifting and carrying techniques that work for you. Write out brief instructions and keep them in your pack.

## Persons with Visual Challenges

- If you have some vision challenges, place security lights in each room to light paths of travel. These lights plug in but have a battery backup in case of power failure.
- If helpful, mark emergency supplies with large print, fluorescent tape or Braille.
- Store high-powered flashlights with wide beams and extra batteries

## Persons with Hearing Challenges

- Store hearing aids in a strategic and consistent place, so they can be located quickly.
- Have paper and pencil in your kit to use if you do not have your hearing aids.
- Install smoke alarms with both a visual and audible alarm. At least one should be battery-operated.
- If possible, obtain a battery-operated TV with a decoder chip for access to signed or captioned emergency reports.

## Persons with Medical Needs

- Always have at least a ten (10) day supply of all your medications and medical supplies (bandages, ostomy bags, syringes, tubing, solutions, etc.).
- If you use oxygen, be sure to have at least a three (3) day supply.
- Store your medications in one location, in their original containers.
- Keep lists of all your medications, including the name of the medication, dose, frequency and prescribing doctor, in your wallet.
- For all medical equipment that requires power, get information regarding back-up power, such as a battery or generator (this includes refrigerators for insulin or other medication needing to be refrigerated).
- Know if your IV infusion pump has a battery back-up and how long it would last in an emergency.
- Ask your home care provider about manual infusion techniques.
- Have written instructions for all equipment attached to the device(s).





# HOME FIRE SAFETY

*If a fire breaks out in your home, you may have less than two minutes to escape before it's engulfed in flames. How can you be sure you and your family will know what to do? **PREPARE, PREVENT, and PRACTICE** so you are **ready for a house fire.***

## **PREPARE**

### **Working smoke alarms:**

- Test your smoke alarms monthly by pressing the test button and listening for the alarm
- For hardwired smoke alarms with a battery backup, change the batteries twice a year. Consider doing this at the same time you change your clocks in the fall and spring
- Smoke alarms should be replaced every 7-10 years
- NEVER disable a smoke detector—only WORKING smoke alarms save lives!

### **Home Escape Plan:**

- Draw a diagram of your house showing doors and windows (use the following graph sheets).
- Determine two escape routes out of every room. Contact your local fire department for help in planning for the safe escape of those with disabilities.
- Identify an outdoor meeting place a safe distance from your home. Make sure everyone knows where it is
- Teach everyone to “get out and stay out” - to leave the house and never re-enter for any reason
- Teach everyone to call 9-1-1 from a neighbor’s house
- Make sure windows are not nailed or painted shut

### **Visible Address:**

- Be sure your address is marked clearly and is visible from the street so emergency crews can find your house quickly
- If you have a locked gate, make sure that 9-1-1 knows the code so responders can get in

## **PREVENT**

### **Heating Equipment:**

- Never use charcoal or un-vented appliances in your home
- Clean/service chimneys and heating systems annually
- Keep combustibles at least three feet away from baseboards and portable heaters. Never leave portable heaters unattended, especially around children and pets!
- Never use extension cords with portable heaters

### **Smoking/Ashes:**

- NEVER smoke in bed!
- Always use sturdy, noncombustible, non-tipping ashtrays
- Extinguish smoking materials in sturdy, non-tip ashtrays—do not throw them into trash cans, shrubbery or bark dust
- Always use a metal container when cleaning ashes from stoves/fireplaces. Place the metal containers away from any buildings/combustibles until the ashes are completely cool.



### Matches and Lighters:

- Keep matches and lighters out of the reach of children!
- Teach children to tell an adult when they find matches or lighters
- Use only lighters with child-resistant features

### Cooking:

- Never leave cooking unattended. Fats and grease are highly flammable.
- In case of a grease fire, smother the fire with the lid to the pan or use an extinguisher. NEVER throw water on a grease fire.
- Keep combustibles away from cooking surfaces—even if the heating elements are not in use. Do not store extra pans or combustibles in the oven.

### Electrical Safety:

- Extension cords should not be used in place of permanent wiring
- Do not overload outlets or extension cords. If you cannot avoid using a number of power cords, such as for Christmas lights, be sure to use power strips with circuit breakers. Use the proper sized cord for the job. Make sure cords are listed and labelled. Never plug multiple extension cords together.
- Make sure cords are in good condition and are not being run through walls, doors, ceilings or under heavy items
- Unplug small appliances, like toasters and curling irons, when not in use
- Do not overlook tripped circuit breakers, as they may be an indication of a dangerous situation

### Flammable Liquids:

- Store paints, thinners, gasoline and other flammable liquids outside of your home and away from heat sources
- Rags or combustibles soaked with flammable liquid should be discarded in metal containers with lids, not in trash cans, to prevent spontaneous ignition

### **PRACTICE: Panic can slow you down—Know what to do and how to do it!**

- When you test your smoke alarms, discuss with young children what the alarm means
- Teach family members to crawl low along the floor in a smoke-filled room
- Teach family members to feel whether doors are hot before they open them. There could be a fire on the other side
- If you have a multi-story home and plan to use an escape ladder, make sure everyone has practiced using it. Climbing down a ladder in the dark can be scary.

### **Hold regular fire drills to practice your plan:**

- Practice during the day and at night so your family is used to getting out of the house under different conditions
- Be sure to including meeting at the designated spot and going to the neighbor's house as if you were going to call 9-1-1
- Keep track of how long it takes to get out. Try to be as fast as possible while being safe
- Remember to bring your pets out with you during your fire drills









### **Do you have . . . .**

- *Working smoke alarms on each level of your home and in each bedroom?*
- *Fire extinguishers in the kitchen and garage?*
- *An escape ladder for upper floors?*
- *A home escape plan?*









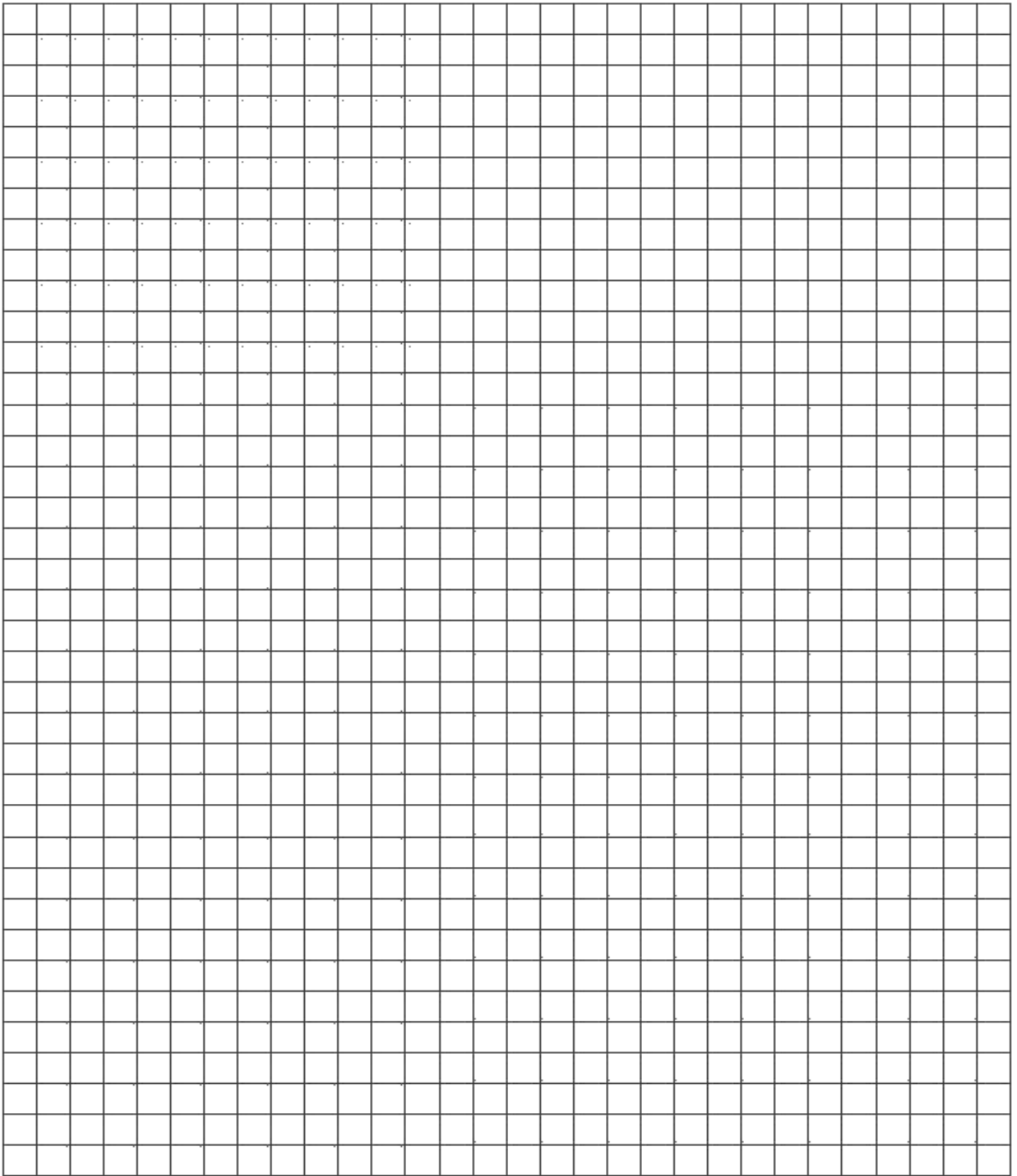

# FIRE ESCAPE PLAN

Use the graph paper on both sides of this page to sketch the floor plan of your home. Establish two exit routes from each bedroom. Use the symbols at the bottom of the page to label your sketch with the safe spots for each type of disaster, and for emergency equipment and supplies.

- |   |                                 |   |                     |
|---|---------------------------------|---|---------------------|
|  | Normal Exit Route               |  | Fire Extinguisher   |
|  | Alternate Route                 |  | Collapsible Ladder  |
|  | Outside Reunion                 |  | Disaster Supply Kit |
|  | Shelter in Place/Safe Room Spot |  | First Aid Kit       |



- |   |                                 |   |                     |
|---|---------------------------------|---|---------------------|
|  | Normal Exit Route               |  | Fire Extinguisher   |
|  | Alternate Route                 |  | Collapsible Ladder  |
|  | Outside Reunion                 |  | Disaster Supply Kit |
|  | Shelter in Place/Safe Room Spot |  | First Aid Kit       |





# SMOKE ALARMS

## Types of Smoke Alarms

### **Battery-Powered**

Battery-powered smoke alarms operate on alkaline batteries. The battery should be checked monthly and replaced twice a year. A good time to do this is when you change your clocks in the fall and spring.

### **Hard-Wired without Battery Back-up**

This type of smoke alarm operates on household electrical current. As long as you have electricity, it will function. If your house loses power, it will no longer function. If you have this type you should also install battery-operated models for back-up.

### **Hard-Wired with Battery Back-up**

These are hard-wired models that have battery back-up so the alarm will still function in case of power failure. If you have this type, the battery should be changed twice a year, or more often if needed.

### **Hearing Impaired**

There are smoke alarms available that have been designed for the hearing impaired. These smoke alarms have strobe lights that, when activated, emit an extremely bright white light that is able to awaken most people from their sleep.

**TIP!**

**CHANGE YOUR SMOKE ALARM BATTERY THE SAME DAY THAT YOU SET YOUR CLOCKS BACK AND FORWARDS**

### **Make Placement a Priority**

At a minimum, there should be a smoke alarm in the hallways and corridors between the sleeping areas and the rest of the house and/or a smoke alarm in the center of the ceiling directly above each stairway.

Additional measures include installing smoke alarms on a wall or the ceiling in each sleeping room.

Because smoke rises, smoke alarms should be mounted high on the wall or ceiling. A ceiling-mounted unit should be placed as close to the center of the room as possible, or a minimum of 12 inches away from the wall. Avoid installing alarms near air supply duct outlets and windows, and between bedrooms and the furnace cold air return. For a wall-mounted unit, the top of the alarm should be 6-12 inches from the ceiling.

Smoke alarms collect dust like everything else in a home. To ensure your smoke alarm is clean, follow the manufacturer's recommendations for cleaning, or use a vacuum cleaner to remove dust and cobwebs.

### **Smoke Alarm Replacement**

It is recommended that smoke alarms be replaced every 7-10 years. At 15 years, there is a 50/50 chance your alarm will fail, and almost 100% chance of failure at 30 years.



# KNOW YOUR FIRE EXTINGUISHER A,B,C's

A fire extinguisher is a storage container for a fire extinguishing agent such as water or chemicals. Fire extinguishers are labeled according to the type of fire they are intended for. Using the wrong type of extinguisher on a fire can make the situation worse.

Traditionally, fire extinguishers have been labeled with the letters A, B, C, or D to indicate the type of fire they are able to be used on. Recently, pictograms or pictures have come into use. A blue pictogram or picture on the extinguisher indicates the type of fire it should be used on, and a black picture with a slash through it indicates the type of fire it should not be used on. Fire extinguishers may have the letter indicators, pictograms, or both.

## Fire Extinguisher Types

### **Type A: Ordinary Combustibles**

To be used on fires in paper, cloth, wood, rubber and many plastics. This is a water-type extinguisher.

### **Type B: Flammable Liquids**

To be used on oils, gasoline, some paints, lacquers, grease in a frying pan or oven, solvents and other flammable liquids.

### **Type C: Electrical Equipment**

To be used on fires in wiring, fuse boxes, and other energized electrical equipment.

### **Type D: Metals**

To be used on combustible metals such as magnesium and sodium.



**Remember—If there is ever a fire in your home, get everyone outside.**

**DIAL 9-1-1**

Fight a small fire only. If the fire gets big, get out! Close doors to slow the spread of the fire and make sure you stay between the fire and an exit.

## Learn How to P A S S

1. **Pull**—Pull the pin. Some extinguishers require the releasing of a lock latch, pressing a puncture lever, or other similar motion.
2. **Aim**—Aim the extinguisher nozzle (horn or hose) at the base of the fire.
3. **Squeeze**—Squeeze or press the handle.
4. **Sweep**—Sweep from side to side at the base of the fire until it goes out. Shut off the extinguisher. Watch for a reflash and reactivate the extinguisher if necessary. Foam and water extinguishers require a slightly different action. **Read the instructions.**

### Buying and Maintaining a Fire Extinguisher

1. If you plan to buy only one type of extinguisher, a multi-purpose dry chemical extinguisher labeled ABC puts out most types of fires.
2. The larger the extinguisher, the more fire it puts out. Make sure you can hold and operate the one you purchase.
3. Ask your dealer or contact your fire department to determine how to have your extinguisher serviced and inspected. Recharge or replace the extinguisher after any use.
4. Extinguishers should be installed near escape routes away from potential hazards

**For more information, contact your local fire department.**



# WILDFIRE PREPAREDNESS

Central Oregon is no stranger to wildfire. Fire is a natural element in forest ecosystems. Today, more people are moving into our local forests and rangelands which creates a Wildland Urban Interface (WUI), creating an area where development interfaces with traditional wildland fuels. Those living in the Wildland Urban Interface should be aware of the risk of wildfire and prepare accordingly.

## There are three ways that structures ignite:

1. When fire reaches such intense radiant heat that a nearby combustible starts burning;
2. When the fire burns right to an object or right to the structure, causing the flames to directly touch and ignite something that will burn;
3. When fiery embers, also known as firebrands, fly through the air and land on the structure or combustibles, starting a fire. This is the most common cause of home loss due to wildfire.

## The Home Ignition Zone (HIZ)

The Home Ignition Zone includes your home and the immediate area surrounding your home, up to 200 feet from the home depending on terrain and vegetation. Keeping your home ignition zone as fire-safe as possible will reduce the chances that your home will ignite during a wildfire. Additionally, neighborhoods with large numbers of closely-packed houses poses more of a risk.

### Your Home:

- Replace wood shake roofs with non-flammable roofing material
- Remove leaves and needles from gutters, roofs and decks
- Remove tree limbs that hang over the roof
- Keep decks free of flammable lawn furniture, door mats, etc. during fire season
- Screen vents and areas under decks with 1/8" metal mesh to keep embers from getting into your house
- Store firewood in a safe location; at least 30' away from your home and deck during fire season

### Within 30 Feet of Your Home:

- Consider the addition of a 0-5' thick non-flammable barrier around your home, up to the foundation itself
- Maintain 30' around your home—lean, green and clean. Remove dead vegetation and keep dry grass trimmed to 4" tall
- Plants directly near the home should be carefully chosen (ideally they should be of a fire-resistant nature) and maintained (well-watered and free of dead materials that could ignite during a wildfire)
- Flammable brush (such as juniper) should be removed

### Within 100 Feet of your Home:

- Remove dead plants and brush
- Remove low branches from trees and shrubs
- Mow grass to 6 inches
- Tree crowns should be spaced 10-15 feet apart to avoid dangerous crown fires
- Driveways leading to the home should also be clear of heavy vegetation on either side, and should be wide enough to accommodate fire-suppression vehicles and personnel.

**Learn more about keeping your home  
safe from wildfire at [www.firefree.org](http://www.firefree.org)**



# EVACUATION

Evacuations are conducted to save lives and to allow responding personnel to focus on the emergency at hand. The most common cause of evacuation in Deschutes County is wildfire. Evacuate promptly when requested!

## Evacuation Orders:

It is important that you follow ALL evacuation instructions immediately for your safety.

## The Evacuation Process:

Officials will determine the areas to be evacuated and the routes to use depending upon the safest option for the specific incident. Law enforcement agencies are typically responsible for enforcing an evacuation order. Follow their directions promptly! You will be advised of potential evacuations as early as possible, but don't wait to leave if you feel unsafe, or if you or your family have special needs that may cause the process of evacuation to take a little longer. Continually listen to your radio and/or TV for announcements from law enforcement and/or emergency personnel.

## If Evacuation Is a Possibility:

Below is a suggested list of items that you should take with you in the event you must evacuate (gather enough for several days). Be sure to add or subtract from your list as it applies to your personal situation. Place these items in your vehicle (make sure each family member has also gathered their items):

- An evacuation plan for your family including where you will go, how you will get there, where your pets will go if they can't go to a shelter with you, and how you will let others know where you will be
- Several changes of weather-appropriate clothing, and sturdy shoes for each family member
- Toiletries
- Hearing aids, glasses, oxygen, etc.
- Special dietary items
- Baby supplies, toys, books, etc.
- Water and snacks (don't forget water for your pets)
- Medications, copies of prescriptions, vaccination records
- Pet food and supplies
- Important papers (insurance policies, health information, etc.) and identification
- Important phone numbers, cell phone and charger
- Park your vehicle facing outwards in your driveway and carry your keys with you
- Locate your pets and keep them nearby; prepare livestock/horses for transport
- Leave windows closed and air conditioning off

<b>Level 1</b> <b>READY</b>
<b>Level 2</b> <b>SET</b>
<b>Level 3</b> <b>GO</b>

## Returning Home:

Emergency officials will determine when it is safe for you to return to your home. This will be done as soon as possible considering safety and accessibility. Be alert for downed power lines and other hazards.

# GO! DESCHUTES COUNTY EVACUATION GUIDE

## LEVEL 1: **READY**

- Be ready for evacuation
- Prepare family with special needs (babies, elders), and pets or livestock
- Check websites, news sites, and listen to the radio or TV for updates
- Police or fire might contact you by text, phone, or a knock

### Before/During Fire Season

- Register for emergency alerts: [deschutesalerts.org](http://deschutesalerts.org)
- Create space around your home ([firefree.org](http://firefree.org))
- Plan how to move pets/livestock
- Keep your car's fuel at least half full
- Know other ways out of your area

## LEVEL 2: **SET**

- Be ready to leave
- There is danger in your area: load your car or be ready to leave on foot
- Go to a shelter or to another place outside of your area
- **THIS MAY BE YOUR ONLY NOTICE**

- Know evacuation plans for your family members in school, assisted living and day care
- Prepare a 72-hour kit
- Pick an out-of-the-area contact who can help you relay information



To request this information in an alternate format, please call 541-388-6501 or send an email to [emergency.management@deschutes.org](mailto:emergency.management@deschutes.org)

## LEVEL 3: **GO!**

- **LEAVE NOW**
- Do not gather things
- Do not protect your home
- Obey police and fire
- Drive calmly: watch for police and fire vehicles
- Do not block roads for police or fire vehicles

### After Evacuation

- Check in at a shelter or online: [www.redcross.org/safeandwell](http://www.redcross.org/safeandwell)
- Take pets to a pet evacuation center
- DO NOT call 911 for non-emergencies
- Don't go back into the fire



The fire departments and law enforcement agencies of Deschutes County assume no liability for the use or misuse of this information, which is intended to provide fire safety and emergency guidelines for residents. For up to date fire information, visit [www.centraloregonfire.org](http://www.centraloregonfire.org)





# SHELTERING IN PLACE

During some emergencies, it may be safest to stay where you are, rather than go outside. Depending on the situation, it may be safest to stay at home and weather the proverbial (or literal) storm, rather than evacuate to a family member's house or a shelter.

## Planning to Shelter-In-Place:

- Keep enough supplies on hand for your family and pets for at least three days, but preferably up to one month if possible (see pages 6-18 for a 40 week guide to gathering emergency supplies).
- Remember that during a disaster, some services and/or utilities may be unavailable for an extended period of time
- Be sure to store shelf-stable foods and one gallon of water per person/pet per day
- NEVER ration water unless told to do so by authorities
- Store the items in an easily-accessible place, and in quantities that are easy to handle
- Keep an extra supply of important items such as medications, baby supplies, pet supplies, special dietary items, etc.
- Remember to rotate your stored items every six months
- Be sure to listen to your radio to stay up to date on the emergency. Authorities will inform you about the status of the emergency, and issue any special instructions such as a boil water advisory
- Plan to have activities for yourself as well as your children such as coloring books, board games or puzzles

## Extended Sheltering-In-Place:

Professionals in emergency services recommend that everyone be prepared to shelter-in-place for longer than three days. Some even recommend storing a month or more of essential supplies. Plan for as long as you realistically can. Winter storms can result in trees and limbs across may roads, heavy snow pack or major flooding. Many natural disasters could result in a power outage or disruption of other essential services for an extended period of time

- Think about the supplies you have stored and how long they would last
- Are there additional supplies you need to store if power or water were out for a month or more?
- How will you ensure sanitation in your home?
- Talk to your doctor, pharmacist, or insurance provider about ensuring adequate supplies of your prescription medications



# EXTREME HEAT

In Deschutes County, summer temperatures can hover in the 90's for weeks at a time. It is not unusual to have numerous days where the temperature reaches over 100 degrees. Fortunately, we have a generally low relative humidity. Whenever possible, avoid prolonged exposure to the heat. Remember that pets, young children and the elderly can be more susceptible to the effects of extreme heat.

Heat kills by taxing the human body beyond its capabilities. Under normal conditions, the body produces perspiration that evaporates and cools you. In extreme heat or high humidity, evaporation is slowed and your body has to work harder to cool itself. In a normal year, an average of 175 Americans die from extreme heat. Young children, the elderly and those who are sick or overweight are more likely to become victims.

## Extreme Heat Terms

**Heat Wave**—Prolonged periods of excessive heat, often combined with excessive humidity

**Heat Index**—A number in degrees F that tells how hot it feels when relative humidity is added to the air temperature. Exposure to full sunshine can increase the heat index by 15 degrees.

**Heat Cramps**—Muscular pains and spasms due to heavy exertion. Although heat cramps are the least severe, they are often the first signal that the body is having trouble with the heat.

**Heat Exhaustion**—Typically occurs when people exercise heavily or work in a hot, humid place where body fluids are lost through heavy sweating. Blood flow to the skin increases, causing blood flow to decrease to the vital organs. This results in a form of mild shock. If not treated, the victim's condition will worsen. Body temperature will keep rising and the victim may suffer heat stroke.

**Heat Stroke**—A life-threatening condition. The victim's temperature control system, which produces sweating to cool the body, stops working. The body temperature can rise so high that brain damage and death may result if the body is not cooled quickly.

## During a Heat Emergency

- Stay indoors as much as possible and limit exposure to the sun
- Stay on the lowest floor out of the sunshine if air conditioning is not available
- Consider spending the warmest part of the day in public buildings such as libraries, schools, movie theatres, shopping malls, and other community facilities
- Eat well-balanced, light and regular meals. Avoid using salt tablets unless directed to do so by a physician
- Drink plenty of water. Persons who have epilepsy or heart, kidney or liver disease, are on fluid-restricted diets; or have a problem with fluid retention should consult a doctor before increasing liquid intake
- Limit intake of alcoholic beverages
- Dress in loose-fitting, lightweight clothing that cover as much skin as possible
- Protect your face and head by wearing a wide-brimmed hat
- Check on family, friends and neighbors who do not have air conditioning and who spend much of their time alone
- Never leave children or pets alone in vehicles
- Be sure pets have plenty of water and shelter from the sun
- Avoid strenuous work during the warmest part of the day. Use a buddy system when working in extreme heat, and take frequent breaks



# FLOODS

Flooding can occur in many places including near any stream, river or other water way. Flooding can also occur in any low-lying area if the amount of rainfall and runoff exceeds the capacity of the storm drain system or ditch.

## Weather Terminology

**Flood Watch**—A watch is used when forecasters believe it is likely that hazardous weather will occur, but are still unsure about its location and/or timing. A watch is issued to give people time to prepare for the event.

**Flood Warning**—A warning is used when forecasters believe that hazardous weather is imminent, or very likely to occur. A warning is used for conditions that would threaten lives or property.

## Preparing for a Flood

- Find out if you live in a flood-prone area
- Consider purchasing flood insurance for your home. Flood **damage and loss is not covered under a homeowner's policy**
- If a flood were to occur, think about how you would keep water from getting in your home
- Keep a battery-operated, or crank-powered AM/FM/NOAA radio on hand in case the power goes out
- Consider keeping sandbags on hand. Sandbags are available at most farm and home improvement stores

## If Flooding is Imminent

- Listen to the radio or TV, or check the internet at [www.wrh.noaa.gov](http://www.wrh.noaa.gov) for watches and warnings issued by the National Weather Service
- Move important items and papers to a safe place in your home, or seal them in plastic bags to protect them
- If you plan to stay in your home, check your supplies of food and water, and other items such as flashlights, batteries and important medications
- If you need to leave, call 511 or visit [www.tripcheck.com](http://www.tripcheck.com) for road conditions

## During a Flood

- The safety of your family is the most important consideration. If you think the flood may reach your home, evacuate immediately. If time permits, turn off utilities (gas, water and electricity) at the main switch or valve
- Secure outdoor equipment, furniture and other moveable objects that might be swept away
- Never walk through flood waters. Even six inches of water can sweep you off your feet
- Do not allow children or animals to play in flood waters. Flood waters are often contaminated with sewage and flood-related chemical spills
- Listen for information from the health department about the safety of drinking water. If there is a problem with wells or public drinking water, the health department will provide instructions for boiling water before drinking it or suggest you use only bottled water
- Never go around safety barricades set up in the road! Two feet of water is enough to float a car, and water can conceal places where roadways and bridges have been washed out





# UTILITY FAILURE

## Emergency Lighting

**Flashlights:** Each person should have their own flashlight. Store extra bulbs and batteries. You can purchase flashlights that you wind or shake instead of using batteries.

### **Before the power goes out:**

1. Locate the main electrical panel or fuse box (it's usually on an interior wall near your electric meter)
2. Be sure to have all breakers and fuses labelled properly. Especially on essential equipment such as water heater, furnace, ovens, etc.
3. If your residence has a fuse box, maintain a supply of spare fuses of the correct amperage
4. Always keep a working flashlight available with extra batteries of the correct size and type.

### **When the power goes out:**

- Check your fuse box or breaker box for blown fuses or tripped circuits. If they are okay, see if neighbors have power
- Call your utility company to report the outage. You may be asked for information or hear a recorded message that the outage in your area has already been reported
- If the outage appears to be long, unplug appliances (water heater, furnace, heaters, stove, etc.) or turn off the breaker on the circuit panel to prevent overloading the system when the power comes back on
- Turn on a porch light and one light inside your home so you and utility crews will know when power has been restored
- Listen to the radio for updates. Or check your utility's outage web page

**When the power comes back on, be sure to systematically energize each breaker starting with lighter loads such as lights, then outlets, and lastly appliances. Space this out over 15-minute intervals.**

If you see sparks or broken/frayed wires, or if you smell hot insulation, shut off your electricity immediately.

- For a circuit breaker panel, shut off the electricity by turning all circuit breaker switches to the "off" position
- Use a wooden stick/dowel to turn off circuit breakers

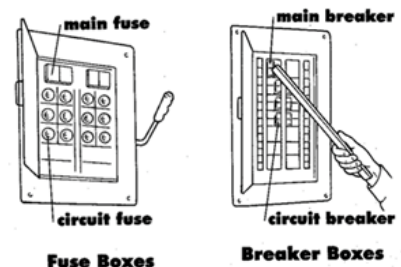

### **HOUSEHOLD TIPS:**

- Your freezer may keep food frozen during a power outage up to two days if you keep the door closed. When the power comes back on, check the food. Throw out any items that have defrosted. Your food will keep for several hours in a closed, full refrigerator
- If it is freezing outside, keep an inside faucet turned on to a steady drip to prevent frozen pipes
- Automatic garage doors and gates won't open if the power is out. Check to see if you have a manual override
- Never cook inside using charcoal or camping stoves. They can produce deadly carbon monoxide gas. Cook outside in a sheltered area, then bring the food inside
- Never connect a home generator to a wall outlet. If used incorrectly, they can ruin your electrical system and start a fire. Also, they can fatally injure utility workers by the back feed of electricity through your home's electrical system. Choose important appliances to plug into the generator and run it as needed

**Natural Gas**—Any odor of natural gas inside your home might indicate a leak. If you smell natural gas or hear blowing or a hissing noise, open a window and quickly leave the building. Turn off your gas at the meter as soon as possible.

1. Locate the shut off valve
2. Use a crescent wrench and turn the rectangular knob one quarter turn clockwise to the horizontal position
3. Call your gas company from a neighbor's home
4. If you turn off the gas for any reason, service should be restored by a professional

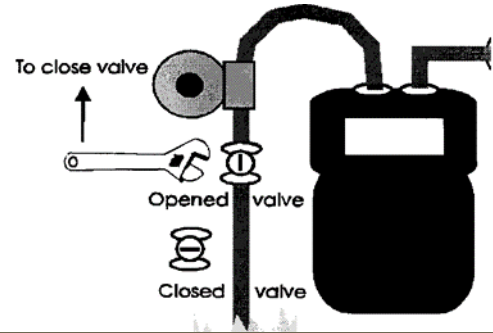

**If you suspect a gas leak:**

**If you smell natural gas, get everyone out and away from the home immediately!**

**DON'T** use your telephone. This includes cellular phones and all types of portable communication and electronic devices that have a battery. These can spark and create a source of ignition.

**DON'T** use matches, lighters or open flame appliances and don't operate electrical switches.

**WATER**—Earthquakes and freezing weather can rupture water pipes and cause flooding if not turned off quickly. Find the location of your home's shut off valve:

→ There is a shut off valve at the water meter, but there may also be one closer to your house

→ Some common places to look for your master shut off valve are:

- In the crawl space or basement where the water line enters the house
- In the garage where the water line enters the wall or ceiling, near the water heater, or by the clothes washer hookup
- Outside, near the foundations of your home, possibly protected by a concrete or a clay pipe ring

**If you don't find a hand-operated master shut off valve, have one installed on the house side of the meter. It may come in handy.**

**Water Meter**

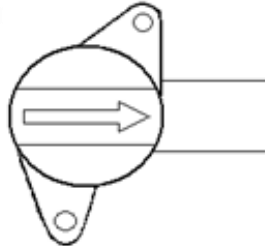

**Open / On**

**Water Meter**

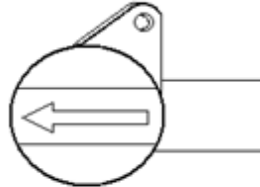

**Closed / Off**

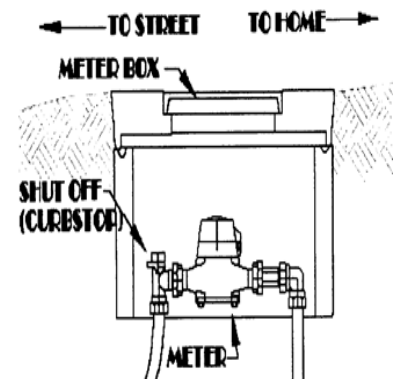

Your sewer system could also be damaged in a disaster such as an earthquake, landslide, or flood. Make sure the system is functioning as designated before using it. This may prevent the contamination of your home and possibly your drinking water supply.



# WINTER STORMS

Winter can bring weather such as snow, ice, freezing temperatures, and windstorms. Being prepared for these types of emergencies can save lives. Monitor weather reports so that you can prepare to lessen the impacts of severe weather.

## Weather Terminology

**Winter Storm Watch**—A watch is used when forecasters believe it is likely that hazardous weather will occur, but are still unsure about its location and/or timing. A watch is issued to give people time to prepare for the event.

**Winter Storm Warning**—A warning is issued when forecasters believe that hazardous weather is imminent, or very likely to occur. A warning is used for conditions that would threaten lives or property.

### **During a storm:**

- Eat regularly and drink ample fluids. Avoid caffeine and alcohol
- Listen to your AM/FM/NOAA radio or your local radio station for weather reports and emergency information

### **If you go outside:**

- Wear several layers of loose-fitting, lightweight warm clothing. Make sure the outer layer is water- and wind-proof
- Cover your mouth with a scarf to protect your lungs from extremely cold air
- Avoid overexertion if possible. Overexertion can bring on a heart attack—a major cause of winter deaths. Stretch before any strenuous activity and take plenty of breaks

### **After a storm:**

- Consult a professional if you notice sagging ceilings, drywall cracking, doors or windows no longer working properly or signs of excessive building load
- If able, clear ice dams, and any other areas around your home of excessive snow
- Keep portions of your roof clear of snow that has the potential to slide off and damage things below
- Watch for and clear areas where snow drifts accumulate

## Winter Preparedness Tips

- Keep rock salt on hand to melt ice from walkways around your house
- Ensure that outside pets have adequate shelter from the elements. Check their water bowls often and keep them from freezing
- Make sure you have sufficient heating fuel or an alternate heat source in case the power goes out. Do not use portable gas heaters or charcoal grills for heating in closed areas
- Insulate pipes to keep them from freezing
- Winterize your home by insulating walls and attics, caulking and weather-stripping doors and windows, and installing storm windows or covering windows with plastic
- Have your vehicle winterized and use traction tires or carry tire chains. Always keep the fuel tank full
- Check battery-powered items in your emergency kits to make sure you have plenty of spare batteries



When packing clothing, it is preferable to include layers rather than one warm, heavy coat or jacket. It is also better to be prepared with polypropylene, wool, silk or other non-cotton fabrics. Cotton retains moisture and loses all insulating qualities when wet. A wet pair of jeans and a soggy cotton shirt wick heat away from the body.



# SANITATION

In a disaster situation, plumbing may not be usable due to disrupted water and sewer lines. Each household should know how to properly sanitize and dispose of human waste in order to avoid infection and the spread of disease.

If the water is off, but the sewer lines are unaffected, toilets can be flushed with stored water. If sewer lines are broken, but the toilets in your home are usable, the bowl can be lined with plastic bags. If it is unusable, substitute a plastic bag in a bucket.

Four types of disinfectant may be used for disinfecting sewage in plastic bags:

- If water is available, it is best to use a solution of one part liquid chlorine bleach to ten parts water (don't use dry bleach, which is caustic and not safe for this type of use)
- HTH or calcium hypochlorite is available at swimming pool supply stores. HTH is intended to be used in solution. It can be mixed according to the package directions and then stored
- Portable toilet chemicals, both liquid and dry, are available at recreational vehicle supply stores. These chemicals are for use with toilets that are not connected to sewer lines. Use as directed
- Powdered, chlorinated lime is available at building supply stores. It can be used dry. Be sure to get chlorinated lime and not quick lime, which is highly alkaline and corrosive

**CAUTION: Chlorinated products that are intended to be mixed with water for use can be dangerous if used dry. Be sure to read and follow the directions on the package.**

## Emergency Supplies Recommended:

- Several five-gallon plastic polyethylene buckets with tight-fitting lids or five-gallon metal containers with tight-fitting lids should be stored as makeshift toilets. A seat can be fashioned from a hole cut in the seat of an old chair, or a toilet seat made to fit the rim of a bucket can also be used. A pool noodle is another low-cost option
- One or more large metal covered garbage cans should be available to contain waste
- A supply of plastic liners (5-6 gallon size) should be stored
- Disinfectant spray, hand sanitizer, deodorizer tablets and air fresheners should be kept nearby
- If you elect to build a latrine, be sure it is lower than any surface water (river, pond, canal, lake, etc.) and is at least one hundred feet away from water. The hole should be 2 1/2 feet deep, 1 foot wide and 4 feet long. Be advised that in many parts of Deschutes County, it will be challenging to dig a hole that deep because of the underlying lava rock. Soil removed from the trench should be placed nearby to shovel in after use. Cover the trench completely when the waste and soil reach within a foot of the top. Use lime or soil after each use to combat odors

The best way to prevent the spread of disease is to make sure you wash your hands for at least 20 seconds after each time you use the restroom and before preparing food or eating.



# HEALTH EMERGENCIES

As you are preparing for hazards like wildfires and floods it's important to also prepare for health emergencies. Health emergencies can vary in size from an outbreak or food poisoning at a community event to a pandemic illness. Sometimes health emergencies can be scary; you can't see, touch, or smell diseases the same way that you can smell the smoke from a wildfire or see the flood waters rising. Although thinking about these things can be upsetting, it's important to learn how to keep yourself and your family as safe as possible.

## What are Federal, State and Local Public Health Agencies Doing to Prepare?

The US Department of Health and Human Services, Oregon state Public Health Division, and Deschutes County Public Health have developed many emergency plans to respond to health emergencies. State and local health departments are also working with healthcare facilities, businesses, faith-based organizations and other community groups to help them prepare.

## What Can You Do To Prepare?

*Start by staying healthy!*

It sounds simple, like what your grandmother used to tell you, but staying healthy can increase your chances of success in any disaster!

- Get a yearly flu shot
- Make sure children are current on immunizations
- Maintain a healthy diet
- Cook foods to the proper temperature and store them in a safe manner
- Get plenty of rest
- Limit consumption of alcohol and tobacco
- Dress appropriately for the weather
- Wear sunscreen
- Follow health advisories from Public Health Officials
- Keep current files of your medical records and a list of prescription medications in a safe location

## Cover Your Cough!

- Cover your mouth and nose with a tissue when you cough or sneeze, or cough or sneeze into your upper sleeve, not your hands
- Put your used tissues in a waste basket
- After coughing or sneezing, wash your hands with warm, soapy water for at least 20 seconds (the time it takes to sing "Happy Birthday" twice) or clean your hands with alcohol-based sanitizer

## Stay Home When You're Sick!

- With many illnesses, you are more contagious when you first become sick. Staying home limits the spread of germs to other people, and can help you get better sooner

**You can find more information about preparing for health emergencies at the following websites:**

[www.cdc.gov](http://www.cdc.gov)

[www.who.int](http://www.who.int)

**During a Health Emergency:**

- Stay informed about the status of the illness (television, radio, newspapers, internet)
- Learn what you can do to protect yourself
- Follow instructions from Public Health officials

**Community Mitigation**

If a lot of people are sick, Public Health Officials may implement something called “Community Mitigation Strategies.” Community Mitigation Strategies are ways that members of the community can work together to limit the spread of disease until a vaccine or cure is available. This can be done in a number of ways:

- Closing schools, daycares, and after-school programs
- Cancelling public gatherings
- Asking businesses to have workers work from home (telecommuting)
- Asking businesses to modify their leave policies

In addition, Public Health Officials may ask that people follow isolation and quarantine guidelines. Isolation is when a person who is sick is asked to stay home for a specified period of time. This helps to ensure that the person doesn’t infect others with the disease. Quarantine is when people who may have been exposed to the disease are asked to stay home for a specified period of time. In some cases, a person can spread an illness before they even know they are sick.

In order for community mitigation strategies to work, community members must follow the instructions from Public Health Officials. Although some of these measures may seem disruptive, it’s important for everyone’s safety.

**The Strategic National Stockpile**

The Strategic National Stockpile (SNS) has large quantities of medicine and medical supplies to protect the American public if there is a public health emergency (terrorist attack, flu outbreak, earthquake) severe enough to cause local supplies to run out. Once federal and local authorities agree that the SNS is needed, medicines and/or supplies will be delivered to any state in the U.S. within 12 hours. Each state has plans to receive and distribute SNS medicine and medical supplies to local communities as quickly as possible. The medication in the SNS is FREE for everyone.

Deschutes County Public Health has worked with other agencies and community partners to develop plans for receiving and distributing our county’s portion of the SNS during an emergency. Many of the supplies (including medical supplies like masks and gowns) will be pushed out to the medical community so that they may continue to treat patients. Medications may be given to the public in a variety of ways, including through a person’s healthcare provider or at a community Point of Distribution (POD).

If there were a need to distribute medication or vaccine to a large number of citizens to help keep them from getting sick, Deschutes County Public Health would open a POD at a location (such as the Expo Center). Citizens who were not sick would be instructed to go to the POD to receive their medication or vaccine. Each person receiving medication or vaccine would be asked to fill out a short health questionnaire. Sick citizens would be instructed to see their doctor or go to the hospital to receive treatment.



# EARTHQUAKES

## Getting Prepared

- Securely fasten water heaters and gas appliances to wall studs
- Repair defective electrical wiring, leaky gas and inflexible utility connections
- Place large, heavy objects on lower shelves. Fasten shelves to walls. Brace tall and top-heavy objects
- Store bottles, glass, china, and other breakables on low shelves or in cabinets that can be fastened shut
- Be sure the house is firmly anchored to its foundation
- Anchor overhead light fixtures
- Know how to shut off all utilities
- Locate safe spots in each room
- Identify danger zones in each room

Whether you are in your home, at work, in school, or in any other type of building, it is important to know how to protect yourself during an earthquake and its aftershocks.

## When the Shaking Stops

- If the electricity is out, use flashlights or battery powered lanterns
- If you smell gas or hear a hissing or blowing sound, open a window and leave the building. Shut off the main gas valve outside. If you turn off the gas for any reason, service should be restored by a professional
- Check for injuries to yourself and those around you
- If there is electrical damage, loose wires, arcing, sparks or smoke, switch off the power at the main control panel
- If water pipes are damaged and leaking, shut off the water supply at the main valve
- Wear sturdy shoes
- Check your home for obvious structural damage. Check chimneys for damage
- Clean up spilled medicines, bleaches, gasoline and other flammable or hazardous liquids
- Visually inspect utility lines and appliances for damage
- Do not flush toilets until you know that sewage lines are intact
- Open cabinets cautiously. Beware of objects that can fall off shelves
- Use your telephone only to report emergency conditions
- Use your cell phone only if regular telephone service is out of order, and then only to report emergency information or obtain emergency assistance
- Listen to the news reports for the latest emergency information. Stay off the streets, unless travel is essential for your safety
- Stay away from damaged areas, unless your assistance has been specifically requested by authorities
- Do not use candles, matches, camp stoves, generators, barbecues, or open flames indoors

**AFTER AN EARTHQUAKE, BE PREPARED FOR AFTERSHOCKS AND PLAN WHERE YOU WILL TAKE COVER WHEN THEY OCCUR.**



**DROP!** - Drop to the ground (before the earthquake drops you)!

**COVER!** - Take COVER under a sturdy desk, table or other furniture that is not likely to tip over. If that is not possible, seek COVER against an interior wall and protect your head with your arms. Avoid dangerous spots near windows, hanging objects, mirrors and tall furniture.

**HOLD ON!** - If you take cover under a sturdy piece of furniture, HOLD on to it and be prepared to move with it. HOLD the position until the ground stops shaking and it is safe to move.

**But what if I am:**

**In bed?** - If you are in bed, stay there. Hold on and protect your head with a pillow.

**In a multi-story building?** - Drop, cover and hold on. Do not use elevators. Do not be surprised if sprinkler systems or fire alarms activate.

**Outside?** - Move to a clear area if you can safely do so; avoid power lines, trees, signs, buildings, vehicles and other hazards.

**Driving?** - Pull over to the side of the road, stop and set the parking brake. Avoid overpasses, bridges, power lines, signs and other hazards. Stay inside the vehicle until the shaking is over. If power lines fall on your vehicle, stay inside until a trained person removes them.

**In a theater or stadium?** - Stay at your seat. Duck down and protect your head and neck with your arms. If you can't duck under the seat, at least put your head and upper body under the seat. Don't try to leave until the shaking stops. Then exit slowly, watching for fallen debris or for anything that could fall on you in an aftershock. Stay calm and encourage others to do the same.

**In the mountains?** - Avoid unstable cliffs or slopes and watch for falling rocks and debris.

**Myth - The "Triangle of Life" is the best way to protect yourself inside a building.**

NOT TRUE. The best survival method inside a building is to drop, cover, and hold on. The "Triangle of Life" advocates that you get next to a large object rather than crouch beneath a desk or table. This will expose you to lacerations and crushing injuries from falling objects and debris. Almost all scientific, government, and relief organizations, including the Red Cross, have examined the "Triangle of Life" concept and are unanimous in recommending that you drop, cover and hold on. Find out more at

[www.earthquakecountry.org](http://www.earthquakecountry.org).





# HAZARDOUS MATERIALS

While the United States has a body of law governing the safe handling, transport and disposal of hazardous materials, accidents can and do occur throughout the country on a regular basis.

## What are “Hazardous Materials?”

By law, a hazardous material is *“any product that corrodes other materials, explodes, or is easily ignited, reacts strongly with water, is unstable when exposed to heat or shock, or is otherwise toxic to humans, animals, or the environment.”* Hazardous materials can include: explosives, flammable gases and liquids, poisons and poisonous gases, corrosives and caustics, nonflammable gases, oxidizers, water reactive materials and radioactive materials.

## What Types of Hazardous Materials Are Found in a “Typical” Home?

Cleaning products:

- Bleach (liquid, powdered cleanser, etc.) - reactive and can form toxic vapors when mixed with other cleaners, especially ammonia or any acid, including vinegar. Irritant to eyes and mucous membranes. Corrosive
- Ammonia (liquid, glass cleaner, etc.) - reacts with acids (such as vinegar) to form a flammable vapor. Skin, eye, nose, and throat irritant. Corrosive if swallowed
- Oven cleaner—skin irritant, inhalation hazard, caustic substance
- Laundry detergent—harmful if swallowed. Mild to severe skin and eye irritant
- Aerosols—container explode if heated. Contents may be highly flammable, irritants, corrosives, toxins or poisons

Beauty Aids:

- Hair sprays (pump or aerosol) - most contain alcohol, which is flammable. Aerosol types have inherent propellant flammability
- Nail polish and removers - flammable
- Perfume, cologne—flammable
- Deodorant (aerosol) - flammable

Garage or Garden Shed Products

- Paints, varnish, paint thinner—flammable
- Gasoline—flammable and irritant
- Diesel—Combustible and suspected carcinogen
- Pesticides, herbicides—poison
- Fertilizer—poison, caustic, oxidizer, explosive when mixed with hydrocarbons (such as diesel).
- Lighter fluid—flammable

Other Materials:

- Propane tanks—flammable gas. Exposure to heat may cause venting or vapor ignition
- Oily rags—spontaneously combust when stored in anything other than airtight containers

**For more information on hazardous household products and effective alternatives, call your local Fire Department. Always call before disposing of possibly hazardous materials. Please remember to dispose of hazardous materials properly.**

## Am I in Danger in My Community?

A wide variety of hazardous materials are transported through, stored, or used in Deschutes County from flammable gases to highly toxic materials. Most hazardous materials are transported into and out of Deschutes County by truck or rail. Common hazardous materials sites include high tech facilities, commercial gas stations, propane distributors, feed and garden stores, and public swimming pools. Once hazardous materials are on site at industrial storage and manufacturing facilities, strict fire and building codes mandate double and triple redundancy safety systems to reduce the impact of human error or mechanical failures.

## What Can I Do to Decrease My Risk of Exposure?

While there is no way to predict hazardous materials accidents, certain areas are at some degree of risk. These include those located near highways, railways, manufacturing, storage or disposal facilities. Prevention of accidents, rather than prediction, is central to avoiding potential damage, loss or contamination from hazardous materials.

All producers of hazardous material substances are required to describe the hazards on the product label. Always read the labels carefully and follow directions completely when purchasing, using or storing these products. Whenever possible, store substances in original containers. Bulk items, such as gasoline for your power equipment, should be stored only in approved containers.

Around the house, remember the acronym **LIES**:

**L**imit – limit the amount of hazardous materials stored to the absolute minimum

**I**solate—store hazardous materials in a separate, locked cabinet whenever possible

**E**liminate—get rid of hazardous materials as soon as they are no longer needed

**S**eparate—do not store potential reactants together. For example, oxidizers with flammables, or bleach with ammonia.

During a hazardous materials incident in your neighborhood, emergency personnel will tell you what to do. They will likely evacuate you to a safe area until the spill is cleaned up. If you witness a hazardous materials transportation accident, spill, or leakage, first distance yourself from the site to minimize risk of contamination. Stay uphill, upwind, or upstream. Try to go at least one-half mile (about 10 city blocks) from the danger area. **CALL 911**. Your local fire department will isolate the area, investigate the situation, and may call in the regional Hazardous Materials response team, if needed.

## How Will I Know What To Do?

In the event of a hazardous materials release in your community:

- Sign up for Deschutes County Emergency Alerts to be notified by emergency services ([Deschutes.org/911/alerts](https://deschutes.org/911/alerts))
- Tune to your local radio or television stations for further information. Local television stations will cover any large event
- If you're in the affected area, follow all instructions from public officials
- Consider adding plastic sheeting and duct tape to your shelter-in-place supplies in order to seal off doors and windows if necessary



# DISASTER PSYCHOLOGY

When disaster strikes, physical assistance may be only part of what survivors need. “Psychological First Aid” for disaster induced stress and trauma may also be required. Severe cases will require the assistance of a mental health professional. For many, however, the best medicine you can provide may be a sympathetic ear.

Disaster-induced stress is a “normal” reaction to an “abnormal” situation.

Disaster survivors normally experience a range of psychological and physiological reactions. Survivors’ reactions may become more intense as the amount of disruption to their lives increases. The strength and type of reaction varies with each person and depends upon several factors:

- Prior experience with the same type or a similar type of event
- The intensity of the disruption
- The emotional strength of the individual
- Individuals feeling that there is no escape, which sets the stage for panic
- The length of time that has elapsed since the event occurred

Pre-empt some of the symptoms by taking care of yourself!

- Try to rest a bit more
- Eat well-balanced and regular meals (even when you don’t feel like it)
- Try to keep a reasonable level of activity. Physical activity is often helpful
- Re-establish a normal schedule as soon as possible. Fight against boredom
- If you are alone, have someone stay with you for at least a few hours a day
- Recurring thoughts, dreams or flashbacks are normal. Don’t try to fight them; they’ll decrease over time

The intensity, timing and duration of post-event psychological and physiological symptoms will vary from person to person. They may be acute or mild and may be immediate or delayed.

## Psychological symptoms may include:

- Irritability or anger
- Self-blame or blaming others
- Isolation or withdrawal
- Fear of recurrence
- Feeling stunned, numb or overwhelmed
- Feeling helpless
- Sadness, depression or grief
- Mood swings

## Physiological symptoms may include:

- Loss of appetite
- Headaches, chest pain
- Diarrhea, stomach pain, nausea
- Increase in alcohol or drug use
- Hyperactivity
- Nightmares
- Inability to sleep
- Fatigue, low energy

During any disaster, mental health workers are available to help survivors, response workers and others affected by the disaster. If you, a family member or friend is in need of assistance, help will be available from the American Red Cross or the Deschutes County Behavioral Health Department.



# FIRST AID

It's an old saying, but, "An ounce of prevention is worth a pound of cure," especially in an emergency situation when seconds count. Here are a few first aid tips that may be useful. First aid is the immediate care given to a person who is injured or ill. Sudden illness or injury can often cause irreversible damage or death to the victim unless proper care is initiated as soon as possible. Because life-threatening situations do occur, everyone should know how to provide emergency care until a victim can be treated or transported to a medical facility. First aid is not intended to replace care by a medical professional. Its intent is to protect the victim until medical assistance can be obtained. For any situation that appears to be life-threatening, it's important to remember to call **911** and get help on the way as soon as possible.

## **The primary purpose of first aid is to:**

- Provide care in life-threatening situations
- Protect the victim from further injury and complications
- Arrange transportation for the victim to a medical facility
- Make the victim as comfortable as possible
- Provide reassurance to the victim

## **As a rule of thumb, call 911 if:**

- The victim has lost consciousness, is unusually confused, or is losing consciousness
- The victim has difficulty breathing or is not breathing in a normal way
- The victim has chest pain or pressure that won't go away
- The victim has persistent pressure or pain in the abdomen
- The victim is vomiting or passing blood
- The victim is having seizures or severe headache or has slurred speech
- The victim has head, neck or back injuries
- The victim seems to have been poisoned

## **First Aid Kit**

You can purchase a pre-made kit or build your own. You should have a kit for your home and in each of your vehicles. Below is a list of basic supplies. Be sure to include any other supplies you and your family may need.

- American Red Cross or other first aid book
- Basic bandages (an assortment of adhesive bandages or athletic tape and moleskin)
- Basic medications (Tylenol, ibuprofen, antacids, antibacterial ointment)
- Basic tools (tweezers, small mirror, scissors, needle, thermometer)
- Cleaning agent/soap
- Emergency blanket
- Antiseptic and moistened towelettes
- Latex gloves
- Additional items such as gauze pads, ace and butterfly bandages, burn gel, Caladryl, sunscreen, ice packs, slings, basic splints, safety pins, etc.

An accident can occur at any time or in any place. If you are the first person to arrive, there are a few basic principles you should follow to protect yourself and the victim.

#### **Call 911 then:**

**Survey the Scene:** Before you help the victim, determine if the scene is safe. If anything dangerous is present, don't put your own life at risk to try and help the victim; you will be of no help if you become a victim too. Summon help and wait for trained people to resolve the situation. If the scene is safe, try to determine what happened and how many victims there may be. Never move a victim unless and immediate, life-threatening danger exists, such as a fire or the threat of a building collapse.

**Primary Victim Survey:** After ensuring the scene is safe, you can turn your attention to the victim. If the victim appears to have head or neck injuries, do not attempt to move them!

First, control any large hemorrhaging (bleeding). Next, check for consciousness. Do this by gently tapping the person and asking if they are okay. If there is no response, this is an indication that a possible life-threatening situation may exist. If the person is responsive and can talk or cry, this indicates they are conscious, breathing, have an unobstructed airway and a pulse. If the victim is unconscious, kneel down next to the head and check for the **ABC's: Airway, Breathing, and Circulation.**

To check the Airway (clear and maintain an open airway), Breathing (restore breathing) and Circulation (restore circulation), place your ear next to the victim's mouth and listen/feel for breath sounds while looking for a rise and fall of the chest. These three steps will determine if cardiopulmonary resuscitation (CPR) is needed.

***If you would like to learn how to perform CPR and First Aid, contact your local fire department, hospital, or the American Red Cross.***

#### **SHOCK - The Silent Killer**

Shock is a life-threatening secondary condition wherein the body's vital physical and mental functions are seriously impaired due to an inadequate supply of oxygenated blood reaching the lungs, heart, or brain. This is the body's reaction to a serious injury, illness, or other traumatic event.

Characteristics of shock include:

- Anxiety (usually the earliest sign), weakness, paleness, sweating and thirst
- Pulse may become rapid and weak
- Patient may become dizzy and pass out
- The more severe the injury or illness, the more likely shock will set in
- Shock can result in death if not treated properly

To treat shock, check your "ABC's," then handle the patient gently, and only if necessary. If conscious, place the victim on his/her back. If unconscious, place face down, with the head to one side, but only if **no neck** injury is suspected. Except in the case of a head injury or suspected neck fracture, lower the head and shoulders and elevate the feet approximately 15 inches. Make sure there are **no broken bones** before straightening the patient out. Protect the patient from becoming cold, especially from the ground below. Continue to reassure the patient.

### Caring for Minor Open Wounds

Blood color for a minor wound is dark red/purple.

- Always wear latex gloves when you come into contact with body fluids.
- Stop the bleeding by applying direct pressure with a clean, absorbent cloth. If a cloth is not available, use your fingers.
- If the blood soaks through, apply a second bandage on top. **DO NOT** remove the first bandage because it will disturb the clotting which has already begun to occur.
- If the bleeding still does not stop, elevate the wound higher than the person's heart.
- Once the bleeding stops, clean the wound gently to get all the debris and dirt out.
- Apply an antibiotic ointment if necessary.
- Wrap the wound firmly in a cloth or bandage. Be careful not to cut the circulation off.

### Caring for a Major Open Wound

Blood color for a major wound can be either dark red/purple or bright red. If the blood is bright red and spurts from the wound, it is arterial. Arterial bleeding is life-threatening and must be treated immediately.

- Cover the wound with a clean dressing and press against it firmly with your hand.
- Elevate the wound higher than the person's heart.
- Cover over the clean dressing with a roll bandage to hold the dressing in place.
- If the bleeding does not stop, add additional dressings over the roll.
- Squeeze a pressure point, which means to press the artery, above the wound, against the bone. The primary pressure points are in the inside of the arm just under the armpit, and on the inside of the leg in the groin.
- Seek medical attention as soon as possible.
- Be careful not to cut off the circulation.

### Bone Fractures

There are two types of fractures:

Closed Fracture: which is a break or crack in a bone that does not puncture or penetrate the skin.

Open Fracture: which is a break in the skin caused by a protruding bone, or there is an open wound in the area of the fracture. Open fractures are more serious than closed fractures.

Some of the symptoms of a fracture are:

- The injured part appears deformed
- Pain is present when attempting to move the part
- Absence of feeling when touched
- Bluish color and swelling in the area of the injury

To treat a fracture:

- Splint the patient before moving
- Pad the splint and place it so that it supports the joint above and below the fracture
- Immobilize a leg fracture by splinting the fractured leg to the unbroken leg if no other materials are present
- If the limb is grossly deformed by the fracture, splint it in place. **Do not try to straighten it**
- Elevate and use indirect (not on skin) ice packs if available





# PET PREPAREDNESS

When disaster threatens, bring your pets inside immediately. Animals have instincts about severe weather changes and will often isolate themselves if they are afraid. Bringing them inside early can keep them from running away. **NEVER LEAVE A PET OUTSIDE OR TIED UP DURING A STORM!** Leaving your pet at home alone can place your animal in danger and could cause a problem for rescuers. Make a plan for what to do with your pets if you have to evacuate your home. Deschutes County does not guarantee companion animal sheltering if you are staying in a shelter. If you plan to stay with friends or family and cannot bring your pets with you, have several options for your pets. Contact local boarding facilities to find out what requirements they have and how much they charge.

## Birds

- Transport in a secure travel cage or carrier
- In cold weather, wrap a blanket over the carrier and warm up the car before placing birds inside
- During warm weather, carry a plant mister to mist the bird's feathers periodically
- Do not put water inside the carrier during transport. Provide a few slices of fresh fruits and vegetables with high water content
- Have leg bands and a photo for ID
- Try to keep the carrier in a quiet area
- Do not let the birds out of the cage or carrier

## Reptiles

- Snakes can be transported in a pillowcase but they must be transferred to more secure housing when they reach the evacuation site. Bring their cage with you
- If your snakes require frequent feedings, carry food with you
- Take a water bowl large enough for soaking as well as a heating pad
- When transporting house lizards, follow the same directions as for birds

## Pocket Pets

Small mammals (hamsters, gerbils, etc.) should be transported in secure carriers suitable for maintaining the animals while sheltered. Take bedding materials, food, bowls, and water bottles

### AFTER A DISASTER

In the first few days after a disaster, leash your pets when they go outside. Always maintain close contact. Familiar scents and landmarks may be altered and your pet may become confused and lost.

The behavior of your pets may change after an emergency. Normally quiet and friendly pets may become aggressive or defensive. Watch animals closely. Leash dogs and place them in a fenced yard with access to shelter and water.

### PET PREPAREDNESS KIT

- Food and water for at least 30 days
- Leash and collar with name tag
- Pet carrier if possible
- Vaccination records
- Medications
- Toys and treats
- Sanitation supplies
- Current picture of pet



# LIVESTOCK PREPAREDNESS

It is especially important for livestock owners to be prepared because of their animals' transportation and shelter needs. Disasters can happen anywhere at any time. Being prepared can help you to act more quickly during a disaster. Familiarize yourself with Deschutes County's PET ahead of time (link at bottom of page).

## Be Prepared to Evacuate as Soon as an Order is Given

- Make a disaster plan to protect your property, your facilities and your animals. Review and update your disaster plan, supplies and information regularly
- Create a list of emergency telephone numbers, including those of your employees, neighbors, veterinarian, state veterinarian, poison control, local animal shelter, county extension service, trailering resources and local volunteers. Include a contact person outside the disaster area. Make sure that all this information is written down and that everyone in your household has a copy

## Sheltering in Place

Depending on the disaster, it may be safest to shelter in place. Think about how you would care for your livestock and keep them safe during a disaster.

- Decide whether to confine your animals to available shelter or leave them out in pastures
- Install a hand pump and obtain enough large containers to water your animals for at least a week
- Identify alternate water and power sources. A generator with a safely stored supply of fuel may be essential, especially if you have electrical equipment necessary for the well-being of your animals
- Secure or remove anything that could become blowing debris. Make a habit of securing trailers, propane tanks and other large objects. If you have boats, feed troughs, or other large containers, fill them with water before high winds prevent them from blowing around. This also increases your water supply

## Evacuation

During some disasters, you may have no choice but to evacuate with your livestock. Plan ahead as much as possible to allow yourself enough time to get your animals safely.

- Before the disaster, make plans for where you can take your animals. Talk to other livestock owners, agricultural schools, the extension service and others in your community for ideas
- Make sure every animal has durable, visible identification
- Plan to take food and other supplies that your animals will need
- Plan to take vaccination records, records of feeding, test records, and ownership information

**For more information on emergency preparedness for large animals, visit [www.hsus.org](http://www.hsus.org), [www.avma.org/disaster](http://www.avma.org/disaster) and [www.petevacuationteam.com](http://www.petevacuationteam.com).**





# MOTOR VEHICLE PREPAREDNESS

What if you were held up in traffic for a prolonged period of time due to weather conditions or a traffic accident? Keeping some basic supplies in your vehicle can make the delay much more comfortable.

If someone on the road needed help, would you have supplies to help them such as a blanket, first aid kit or flares?

## Winter Storms

- If you are caught in a storm, stay in your vehicle until you are rescued. Never attempt to walk from the vehicle unless you can see a definite safe haven ahead
- Run your engine for brief periods of time to provide heat and recharge the battery. Leave a window cracked to avoid a buildup of deadly carbon monoxide
- Check to ensure that your vehicle's exhaust pipe is free from snow

## Floods

- Get out of your vehicle and move to high ground
- Never attempt to drive across a flooded road. Flood waters can conceal areas where the road has been washed away or other hazards
- A foot of water exerts about 500 pounds of force against a vehicle. Your vehicle can easily be swept away, even in only two feet of water

## Earthquake

- Stay in your vehicle
- Pull to the side of the road. Turn off the ignition and set your emergency parking brake
- If possible, stop clear of buildings, overpasses and utility wires
- When the shaking has stopped, proceed cautiously. Be careful of downed trees and power lines

## Basic Emergency Supply Kit for your Car

- Bottled water or juice
- Energy or granola bars
- Pop-top canned fruit
- Dried fruit or trail mix
- Napkins or paper towels
- Cell phone charger
- Flashlight and batteries
- Work gloves
- Tire chains
- Blanket
- Jumper cables
- First aid kit
- Flares or warning triangles
- Maps
- Extra warm clothes, such as jacket, hat and mittens or gloves
- Other supplies such as diapers, formula, dog leashes, etc.

## STAY OUT OF PARKED VEHICLES IN THE SUMMER!

During hot weather, heat can build up rapidly in a closed or nearly closed car. Children, the elderly, and pets can die of heat stroke in a matter of minutes when left in a closed vehicle.



## DESCHUTES ALERTS EMERGENCY NOTIFICATION SYSTEM

Get notified about emergencies and other community alerts via your home phone, cell phone, text message or by email by signing up for our Deschutes Alerts program.

This notification system helps local officials provide you with critical information quickly in a variety of situations such as fire, flood, unexpected road closures, missing persons and evacuation of buildings or neighborhoods.

In the event of an emergency, local officials will use the Deschutes Alert system's emergency notification function to call homes and businesses in the affected area. If you do not have a landline phone, you will not be notified unless you register another contact option! If you register other contact options, such as your cell phone, work phone, or email, you can be notified even when you're not a home.

You specify how you want to be contacted. For example, you can tell the system to call your cell phone and work phones, or just text your phone or send an email. Whichever form of communication works best for you! You can also specify multiple locations in Deschutes County you care about such as your house, your parents' house, or your children's school.

If we can't reach you, we can't alert you, so sign up today!

**Sign up online**

**[deschutes.org/911/alerts](https://deschutes.org/911/alerts)**





## OTHER AREA RESOURCES

- Air Quality Index by Department of Environmental Quality: [www.deq.state.or.us/aqi/](http://www.deq.state.or.us/aqi/)
- Bend Neighborhood Associations: 541-388-5573, [www.bendoregon.gov/community/neighborhood-associations](http://www.bendoregon.gov/community/neighborhood-associations)
- Bend Winter Preparedness: [www.bendoregon.gov/services/winter-tips](http://www.bendoregon.gov/services/winter-tips)
- Central Oregon Emergency Information Network: [coemergencyinfo.blogspot.com](http://coemergencyinfo.blogspot.com)
- Dispatch (Non-Emergency): 541-693-6911, [www.deschutes.org/911](http://www.deschutes.org/911)
- Department of Geology and Mineral Industries (DOGAMI) HazVU: <http://www.oregongeology.org/sub/hazvu/>
- Earthquake mapping tool: [earthquake.usgs.gov/earthquakes/map](http://earthquake.usgs.gov/earthquakes/map)
- FEMA Region 10 Headquarters: 425-487-4600, [www.ready.gov](http://www.ready.gov)
- InciWEB Wildland Fire Information Portal: [inciweb.nwcg.gov/state/38/0/](http://inciweb.nwcg.gov/state/38/0/)
- Map Your Neighborhood Program: [www.preporegon.org/MYN\\_overview](http://www.preporegon.org/MYN_overview)
- National Weather Service (Pendleton, OR): <http://www.weather.gov/pdt/>
- Oregon Office of Emergency Management: 503-378-2911, <http://www.oregon.gov/oem>
- Oregon Smoke Information: [oregonsmoke.blogspot.com](http://oregonsmoke.blogspot.com)
- Project Wildfire: [www.projectwildfire.org](http://www.projectwildfire.org)
- Red Cross of Central and Eastern Oregon: 541-382-2142, [redcross.org](http://redcross.org)
- TripCheck: 511, or [www.tripcheck.com](http://www.tripcheck.com)
- “Unprepared: Will we be Ready for the Megaquake in Oregon” documentary: [www.opb.org/news/series/unprepared/](http://www.opb.org/news/series/unprepared/)

OR Contact the Deschutes County Sheriff’s Office  
or your local police or fire department



**Deschutes County Emergency Management  
63333 Hwy 20 West  
Bend, OR 97703  
541-388-6501**